

McHale



Fusion Vario Baler & Wrapper Operator Instruction Manual Issue 2

(valid to serial number 900117)

McHale
Ballinrobe
Co. Mayo, Ireland

Tel: +353 94 9520300
Fax: +353 94 9520356
Email: sales@mchale.net
Website: www.mchale.net



CLT00489_4

This page is intentionally left blank.

McHale Fusion Vario Baler & Wrapper

Thank you for buying this **McHale** machine, you have chosen wisely!
Given proper care and attention, you can expect it to provide you with
years of dependable service.

Warranty/Guarantee

Attention End User!

Please ensure your machine is fully registered with **McHale**,
by your dealer, at the time of delivery.
Failure of the dealer to register the machine will render your warranty void!
You can check the registration of your machine by visiting www.mchale.net.

It is important to quote the machine serial number when ordering spare parts or
requesting technical assistance. Space is provided below to record machine details.
See "Description of the serial number plate" on page 29.

Serial number:	
Year of manufacturer:	
Date of delivery:	

If you require further copies of this instruction manual,
please quote part number: CLT00489

Due to a policy of continuous product development and improvement, **McHale**
Engineering reserves the right to alter machine specifications without prior notice and
any obligation to make changes or additions to the equipment previously sold.

Please note that all specifications marked with an  in this manual only relate to
certain models or optional equipment. Also these specifications may not be available
in all countries.

It is vital to replace defective parts of the machine immediately and to use only genuine
McHale spare parts, as these are designed and manufactured to the same standard
as the original machine. Spare parts can be obtained from your **McHale** dealer.

Table of contents

1	Introduction	8
2	Product information	9
2.1	Designated use of the machine	9
2.2	Front view	10
2.3	Rear view	11
2.4	General dimensions & specifications	12
2.5	Tractor attachment	12
2.6	Machine specifications	13
2.7	Tyre specifications	13
3	General safety	14
3.1	Be aware of all safety information	14
3.2	Follow all safety instructions	14
3.3	Store all items carefully	15
3.4	Protective clothing	15
3.5	In case of emergencies	15
3.6	Stay clear of rotating elements	15
3.7	Operating the machine	15
3.8	In the event of a fire	16
3.9	General safety warnings	16
4	Specific safety warnings	20
4.1	Electronic safety warnings	20
4.2	Hydraulic safety warnings	20
4.3	Noise level	21
4.4	Fire precautions	21
4.5	Special safety devices/instructions	21
4.6	Safety instruction decal locations	22
4.7	Safety warnings & instructions explained	23
4.8	Description of the serial number plate	29
4.9	Machine lifting guidelines	30
5	Tractor requirements & preparation	31
5.1	Tractor requirements	31
5.2	Control box installation	32
5.3	Attaching to drawbar	32
5.4	Attaching 'break-away' brake	32
5.5	Attaching the machine to a 540 rpm PTO	33
5.6	Lighting system	33
5.7	Machine set-up & the tractor hydraulic system	34
5.8	Which hydraulic system is used?	35
5.9	Hydraulic spool valve setup	36
5.10	Attaching hydraulic hosing to the tractor	36
5.11	Connecting the control box	37

McHale Fusion Vario Baler & Wrapper

6	Baler requirements & preparation	38
6.1	Net requirements	38
6.2	Care of the net roll	38
6.3	Care of the net wrapping system	39
6.4	Loading & operating the netter system	39
6.5	Net layer adjustment setting	41
6.6	Chopper unit knife removal & installation	43
6.7	Automatic lubrication system	47
6.8	Greasing	48
6.9	Gearbox oil	49
6.10	Tyre inflation pressures	50
6.11	Wheel chocks	51
6.12	Drawbar and PTO shaft stand usage	51
6.13	Drawbar adjustment	53
6.14	PTO shaft adjustment & maintenance	54
7	Electronic control system	56
7.1	Control box functions	57
7.2	Control box features	58
7.3	Automatic operation	62
7.4	Menu structure	64
7.5	Warning messages	70
8	Wrapper operation	77
8.1	Loading plastic film	77
8.2	Plastic film requirements	79
8.3	Wrapping process	80
8.4	Dispenser adjustment	81
8.5	Cut and hold system	82
9	Road traffic safety & operation	85
9.1	Before travelling on any public roadway	85
9.2	Road transportation	86
9.3	Road transportation with side tip attached	86
9.4	'Break-away' brake	87
10	Field operation & baler adjustments	88
10.1	Break-in period	88
10.2	Swath preparation	88
10.3	Pick-up reel height adjustment	89
10.4	Crop roller adjustment	89
10.5	Unblocking system	90
10.6	Chopping system	91
10.7	Selectable knives	91
10.8	Bale density gauge	92
10.9	Tailgate safety lock	92
10.10	Spare film holders & door latch safety	93
10.11	Net tension adjustment setting	94
10.12	Net brake adjustment	96
10.13	Brakes (Air/Hydraulic)	97
10.14	Adjusting pick-up float springs	99

McHale Fusion Vario Baler & Wrapper

10.15	Chain adjustments	100
10.16	Adjusting belt alignment	103
11	Accessories & optional equipment	105
11.1	Drawbar hitch options	105
11.2	Stand options	105
11.3	Brake options	106
11.4	Side tip option	106
11.5	Selectable knives	106
11.6	Crop roller	107
11.7	Dispenser gear options	108
12	Attachments	109
12.1	Side-tip	109
13	Machine maintenance	114
13.1	Maintenance intervals	114
13.2	Tightening torque values	117
14	Storage	118
14.1	End of season	118
14.2	Start of season	119
15	Troubleshooting	120
15.1	Troubleshooting overview	120
16	Certification & Warranty	124
16.1	Declaration of Conformity	124
16.2	PDI Form	124
16.3	Change of ownership pre-checks	124
16.4	Limited Warranty	124

McHale Fusion Vario Baler & Wrapper

This page is intentionally left blank.

1

Introduction

The **McHale Fusion Vario** Baler & Wrapper is a completely new product. This product combines the baling process with the wrapping process, in one machine. The design has been developed based on years of extensive research and development in the field of round bale wrappers and balers. Given proper care and attention, the **McHale Fusion Vario** will provide years of reliable and dependable performance.

Please do not assume that you know how to operate and maintain your machine before reading this manual carefully. In order to prevent misuse, damage and accidents, it is very important that everybody who will operate the **McHale Fusion Vario** be a fully trained operator. They must read and fully understand all of the contents of this manual, before operating the machine, paying particular attention to the following:

- Safety instructions
- Functions
- Controls (hydraulic & electrical)

It is highly recommended to get acquainted with any new machinery slowly. Take time to learn and understand all of the features of the machine. Proficiency will increase as more experience is obtained.

If you have any questions in relation to the instructions in the manual, please contact your **McHale** dealer. It is highly recommended that training be sought from your local **McHale** dealer.

The operator is solely responsible for the safe use and maintenance of the machinery, in accordance with this manual. Keep this manual safe and make sure it remains with the machine, at all times.

2

Product information

The **McHale Fusion Vario** is protected against many dangers to itself while being operated from the control box in both manual and automatic cycles. However, it is of the utmost importance for the safety of the operator and for others, that the operator pays attention to all warnings and instructions given in this manual. In particular all safety devices, decals, guards and controls must be in place and in fully functioning condition. Never try to clear any malfunction when the tractor is switched on or while the machine is running. Keep the “Danger Zone” (An area around the machine, detailed in “Danger Zone” on page 17) free of all persons and animals at all times, while the machine is in operation. This manual must be read and fully understood by anyone who will operate the machine.

2.1 Designated use of the machine

The **McHale Fusion Vario** is exclusively designed for normal use in agricultural applications. The machine has been designed to pick up and compact stalks from the ground, to produce cylindrical bales of forage, in varying sizes, which are in turn wrapped with plastic stretch film for the purpose of storing as fodder for feeding livestock. This designation includes the movement of the machine, between fields by track or road, incidental to the round baler/wrappers main use. The manufacturer will not be held responsible for any loss or damage resulting from machine applications other than those specified above. Any other use the machine may be put to, is entirely at the owners/operators risk.

The designated use of the machine includes that:

- the operating, maintenance and repair instructions given by the manufacturer will be strictly fulfilled
- exclusively persons who are familiar with it and instructed about the risks are entitled to operate, maintain and/or repair the machine
- the relevant health and safety requirements, that may be in force in the country of use, will be strictly followed
- no other equipment or accessories, other than released by **McHale**, are installed in the machine. The use of any other equipment or accessory is entirely at the owner/operators risk. In such cases, unauthorised modifications/changes exclude any liability of the manufacturer.



WARNING: Loss of machine validity

By any alteration of safety equipment, the declaration of conformity and the CE sign loses it's validity for this machine.

2.2 Front view

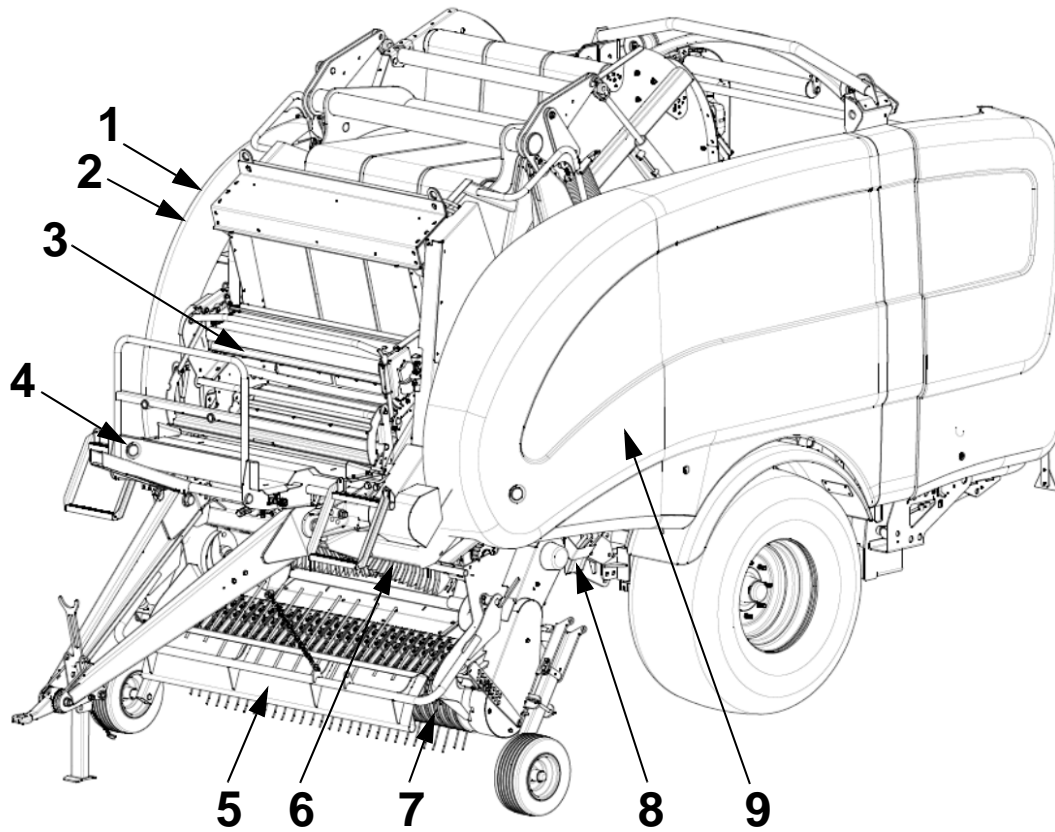

No.	Machine Function
1	Hydraulic section (Inside cover)
2	Stop switch B (Inside cover)
3	Netter unit
4	Chamber door pressure clock
5	Crop guard or crop roller
6	Chopper unit
7	Pick-up reel
8	Wheel chocks
9	Knife blanks (Inside cover)

2.3 Rear view

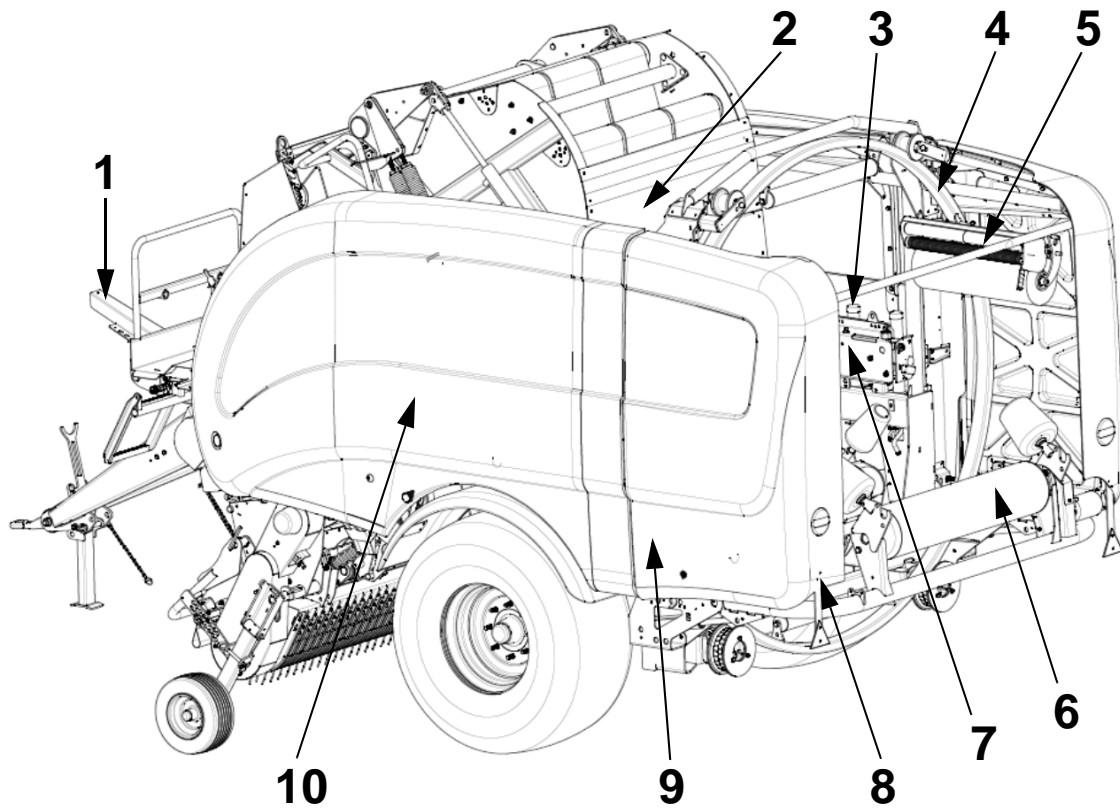

No.	Machine function
1	Hose carrier
2	Chamber door/tailgate
3	Spare film section (inside cover)
4	Dispenser ring
5	Dispenser
6	Table roller
7	Cut & hold unit
8	Stop switch A
9	Dispenser access door
10	Drive side

2.4 General dimensions & specifications

Transport length	6.3 m (248")
Transport width	2.95 m (116")
Transport height	3.3 m (130")
Transport weight	6,500 kg (14,330 lbs)
Tyre dimensions	650/50 R22.5
Tyre pressure	1.65 bar (24 psi)
Tyre dimensions (Pick-up reel)	170/60 - 8
Tyre pressure (Pick-up reel)	2.07 bar (30 psi)
Maximum road speed	40 km/h (25 mph)
Brake system	Hydraulic brakes Air brakes*

Check with national road traffic regulations in the individual country!

2.5 Tractor attachment

Drawbar	Low drawbar High drawbar *
PTO speed	540 rpm
Lighting	12 V / 7-pin socket
Electrics	12 V, 20 A euro socket
Hydraulic systems	Open-Centre, Closed-Centre, Load-Sensing
Minimum pressure	180 bar (2,610 psi)
Minimum flow rate	45 l/min (9.9 gal/min) @180 bar (2,610 psi)

(*) May not be available in all countries, check with your **McHale** dealer for availability in your country.

Units are given in both metric and UK imperial values, with the latter shown in brackets.

2.6 Machine specifications

Bale chamber diameter (Baling & Wrapping)		1.1 - 1.5 m (43.3 - 59")
Bale chamber diameter (Baling only)		1.0 - 1.65 m (39.4 - 65")
Bale chamber width		1.23 m (48")
Pick-up width		2.00 m (78")
Net tying	Net width	Max. 1.26 m (49.5")
	Net length	2,000 m / Max. 4,200 m
Plastic film	Film width	750 mm (29.5")
	Film stretch	70% (64% & 55% optional)
	Film layers	2+2; 2+2+2; etc.
	Film storage	12 Rolls (+ 2 Rolls on dispensers)
Dispenser rotary speed		Max. 36 rpm

2.7 Tyre specifications

Tyre type	Pressure
650/50 R22.5	1.65 bar (24 psi)
170/60 - 8 (Pick-up tyre)	2.07 bar (30 psi)

3

General safety

3.1 Be aware of all safety information

Follow all safety precautions and practice safe operation of machinery, at all times.

Warning, Caution, Information & Environmental Messages:

When reading this manual, pay particular attention when you see the symbols below i.e. Warning, Caution, Information & Environmental. They will be used at various points in this manual and may also appear on safety decals on the machine. The purpose of these messages are to ensure that the most important information stands out from the rest of the text.



WARNING: This symbol indicates a potentially hazardous situation, that if not avoided could result in machinery damage, personal injury or even death.



CAUTION: This symbol indicates a potentially hazardous situation, that if not avoided could result in machinery damage or personal injury.



INFORMATION: This symbol is used to identify special instructions or procedures which, if not followed strictly, could result in machinery damage.



ENVIRONMENTAL: This symbol reminds you to respect the environment in relation to the correct disposal of waste material.

3.2 Follow all safety instructions



Using this manual, read all safety instructions, messages and be aware of the meanings of all safety decals. If safety decals are damaged or missing due to wear and tear or component replacement, ensure that they are replaced. Refer to the Decals Section in this manual (or spare parts book provided) to see the spare part codes for the relevant decals, which are available from your **McHale** dealer.

As with all machinery, learn all operations and use controls by reading this manual thoroughly. Do not attempt to let anyone operate this machine without being fully instructed.

3.3 Store all items carefully



Store all attachments such as spare net rolls, films rolls and any other stored items in a secure and safe manner so as to prevent items from falling. Keep storage areas clear of bystanders and children.

3.4 Protective clothing



Always wear clothing and safety equipment that is fit for the job at hand, never wear loose clothing. In the event of loud noises, wear suitable protective hearing devices. Use of mobile phones or radio/music headphones are not recommended while operating machinery as these impair the operators attention.

3.5 In case of emergencies



In the event of any accident, emergency equipment should be kept close at hand. A first aid kit and fire extinguisher along with emergency phone numbers should always be available to machine operators.

3.6 Stay clear of rotating elements

Serious injury or death can result from entanglement of clothing or body parts with PTO shafts, drivelines and other rotating and moving components.

Keep all guards in place at all times, only wear close fitting clothing and ensure that tractor engine has stopped, key removed and that PTO has stopped turning before carrying out any adjustments, connections or cleaning of PTO driven equipment.

3.7 Operating the machine

In order to avoid serious injury or even death by being pulled into the machine:

- Never attempt to feed net or crop into the baling chamber or attempt to unplug pick-up area while the baler is running
- Disengage the PTO, apply handbrake, shut the tractor engine off and remove the key from the ignition
- Stand well clear of the baler and tractor when the machine is operating

3.8 In the event of a fire



In the event of a fire, the following is given, only as a guideline procedure, as it is in the operator's decision to ascertain the seriousness and hence the solution to the situation.

1. Switch control box to manual mode (See "Control box functions" on page 57). Immediately tip bale off rear roller and leave roller in tipped position.
2. Eject the bale from the baling chamber by opening the chamber door.
3. Move the tractor and baler away from the flammable material.
4. Disengage the PTO, turn off the tractor and remove the key from the ignition.
5. Remove all hosing and electrical looms from the machine.
6. With all connections removed, disengage the drawbar from the tractor.
7. Drive the tractor away from the baler.
8. Using a suitable fire extinguisher, put out all the fires.



NOTE: Fire Prevention

It is recommended that the baler be kept reasonably clean and free of build-ups of crop, lubricants, etc. This will help to reduce the risk of fires.

3.9 General safety warnings

Read and understand this operator manual before using the machine. If any of the instructions appear unclear do not hesitate to contact your **McHale** dealer.

Only competent persons who have read and fully understood this manual are qualified to operate this machine. The owner of this machine is obliged, by law, to ensure that every operator understands all of the functions, controls, working processes and safety warnings, before operating the machine.

Safety devices

- All safety devices such as guards, protection parts and safety controls must be in place and in fully functioning condition. It is forbidden to operate this machine with defective or incomplete safety devices.

Stop switches

- There are two 'Stop' switches located on the machine, one on the back left hand corner (A) and one on the right hand side (B) inside front panel. Stop switches are used to disable all electrical outputs. Push to stop (which displays a warning on the control box, see "Warning messages" on page 70) and turn clockwise to reset. In normal operation, both of these stop switches must be in the reset position.

McHale Fusion Vario Baler & Wrapper



Figure 3.a - Stop switch A located on back left hand corner of back left panel

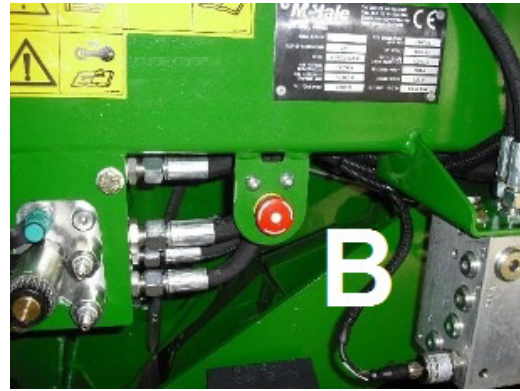

Figure 3.b - Stop switch B located on right hand side inside front right panel

Danger Zone

- The 'Danger Zone' is the area around the rotating dispensers (approx. 2 metres radius from the rotating centre axis) & (a minimum of 5 metres) at the back of the machine to allow for safe bale discharge.



NOTE: "Danger Zone" can vary in size

The operator must be aware of the 'Danger Zone' which can vary in size, depending on operating conditions, i.e. hilly terrain.

- It is the operator's responsibility to ensure that there is no person in the 'Danger Zone' while operating the machine, especially during start up.

Before repair or reassembly

- Safe lifting gear of sufficient capacity must be used for machine assembly. All chains and slings used must be in good condition.

Before operation

- The operator must ensure that the manufacturer's instructions for attaching and detaching the machine are followed. This includes the drawbar attachment, the electric and hydraulic lines, in particular the lighting and brake system.
- The operator must ensure that all covers are closed and all safety devices are in operating mode
- The operator must ensure that there is no person in the "Danger Zone"
- Always be familiar with the health and safety requirements that may be in force in the country of use

During operation

- While operating this machine on hilly or sloping ground the operator must take extra precautions, in particular the "Danger Zone" is increased in such conditions as bales are more likely to roll away, causing a potential risk.

McHale Fusion Vario Baler & Wrapper

- The operator must ensure that there is a minimum of 4 m clearance between the machine and any obstacle above, in particular electrical high voltage lines.
- Never operate the machine with dispenser safety guards damaged or missing
- Be careful when working with the cut & hold. Remember that the accumulators are under pressure.
- Avoid contact with the knife
- Do not attempt to clamp plastic film in the cut & hold mechanism
- Particular care must be taken, if the machine is left idle for any extended period, to ensure that all sensors and safety features are working correctly.



WARNING: Do not carry people or animals on the machine

The operator must ensure that no persons or animals are carried on the machine at any time or are hidden under the machine (on the tractor persons are only allowed to sit on the relevant seats)

Before travelling on public roads

- The owner of this machine is obliged by law to ensure that every operator has got a valid driving licence and is familiar with the road traffic regulations relating to the country of use.
- Always ensure that the electronic control box and oil supply are switched off. When operating in LS mode with 'Power beyond' connections, the feed-line must be disconnected before travelling on a public road.
- Always attach the dispenser safety chain.
- When parking, both wheels of this machine have to be blocked using the wheel chocks and hand brake should be applied according to the road traffic regulations, relating to the country of use.

Performing maintenance

- Maintenance and repair work on the **Fusion Vario** should always be carried out in accordance with this manual
- Maintenance and repair work exceeding the content of this manual should only be carried out by qualified persons or your **McHale** dealer.
- When conducting maintenance work tie long hair behind your head. Do not wear a necktie, necklace, scarf or loose clothing when you work near the machine or moving parts. If these items were to get caught, severe injury could result.
- Before working on this machine, such as replacing net/film rolls, clearing forage away from any part of the machine, or altering any setting, the operator must ensure the following:
 - (a) The tractor has definitely stopped moving
 - (b) The hand brake is applied

McHale Fusion Vario Baler & Wrapper

- (c) The engine is shut down
- (d) The ignition key is removed
- (e) PTO shaft is removed from PTO stub
- (f) Electronic power supply and control box is disconnected
- (g) Hydraulic oil supply is switched off
- (h) Chamber door lock is applied

** It is forbidden to open any safety guards or to carry out any work on the machine, unless the above specified precautions have been carried out.*

- When conducting maintenance work always support the machine properly. Where possible, lower the attachment or implement to the ground before you work on the machine. If it is not possible to lower the machine or attachment to the ground, always securely support the machine or attachment. Do not work under a machine that is solely supported by a jack. Never support the machine with props that may break or crumble under continuous load.
- Never disable any electrical safety circuits, tamper with safety devices or carry out any unauthorised modification to the machine.
- Avoid heating near pressurised fluid lines, as pressurised lines can be accidentally damaged when heat goes beyond the immediate flame area.
- Regular clean down is recommended in order to maintain the machine in a safe and reliable working condition. **McHale** recommend that the machine be blown down with an air line, as opposed to a pressure washer, due to the dangers involved with pressure washing and to protect the overall paint work on the machine. If, despite our advice, a pressure washer is used then take extreme caution and operate from ground level only. Never climb onto any part of the machine, while pressure washing, due to the fact that all metal surfaces become extremely wet and slippery and always ensure that the tractor has been shut down, with the ignition key removed.

During inspection

- If carrying out an inspection during machine operation within the “Danger Zone” (**highly dangerous and NOT recommended!**), then there should be a fully trained and competent second person operating both the tractor and baler controls. If at any time the second operator loses sight of the inspector, turn off all tractor power immediately! Such inspection should only be carried out if all guards are fully in place, the machine is on level ground and a safe distance is kept from any hazards on the machine i.e. pick-up region.

4

Specific safety warnings

4.1 Electronic safety warnings

- This machine is equipped with electronic parts and components which comply to the EMC directive 2004/108/CE but still may be influenced by electromagnetic transmissions of other apparatus, such as welding machines, etc.
- Check electric cables regularly for signs of breakage or wear. If in doubt always replace (faulty safety circuits will cause risks).
- Do not modify any safety circuits.

4.2 Hydraulic safety warnings

- The maximum pressure in the hydraulic system of this machine should not exceed 210 bar.
- Always ensure the system is not under pressure before working on the machine. Oil under pressure can penetrate the skin and cause injury. Beware of pipes under accumulator pressure, depressurise lines by unthreading connections extremely slowly.
- Hydraulically actuated devices, such as pick-up, cutting device and wrapping ring, must be blocked mechanically against movement, before working on the machine.
- If any hoses are removed or replaced ensure they are marked and re-installed to the correct position during re-assembly.
- Check hoses regularly for signs of leakage or wear. If in doubt always replace. The recommended maximum working time of hoses should not exceed 5 years. Only use exact specification **McHale** genuine replacement parts.
- Do not work on hydraulic systems unless you are qualified to do so. This work should only be carried out by qualified persons or your **McHale** dealer.

4.3 Noise level

- The European Regulation 86/188/EEC directs employers and employees to control the noise level at work. The noise level at field work may differ according to the tractor, ground, crops and other environmental conditions.
- In normal conditions, whilst driving the **McHale Fusion Vario**, the noise level to the driver's ear does not exceed 70 dB (A) with the rear screen of the tractor cabin open. The common noise level of the machine and the tractor is primarily influenced by the tractor noise (radio is an additional noise source). It is recommended to operate this machine with closed cabin windows.

4.4 Fire precautions

- Be aware that crops are easily inflammable.
- Do not smoke or make use of any open fire next to the machine.
- A functioning fire extinguisher should always be available on the tractor.
- The machine is to be kept clear of oil, grease, crops or any other flammable material at all times.
- Do not continue to work with overheated parts, cables or pipes, unless you have identified and eliminated the reason for overheating.

4.5 Special safety devices/instructions

- According to European safety regulation, the covers of this machine are designed to be opened only by the aid of a special tool and to be closed without a tool. To unlock the covers, the locks should be turned slightly anti-clockwise with a 13 mm spanner or flat blade screwdriver. To lock the covers push the cover towards the chassis until the fasteners lock into place. It is forbidden to operate the machine without the covers or with them open. The owner of the machine is obliged, by law, to ensure that all covers are installed on the machine and are in good functioning condition.
- When maintenance or repair work has to be carried out at the open bale chamber, the additional upper chamber lever valve must be in the locked position. Before the upper chamber can be closed it has to be unlocked again.
- Before replacing the knives of the chopping system, make sure that all knives are in the 'UP' position. Always use protective gloves when working at the chopping system.
- Avoid contact with the plastic film cutting knives.

4.6 Safety instruction decal locations



Figure 4.a - Decals on the front of the Fusion Vario

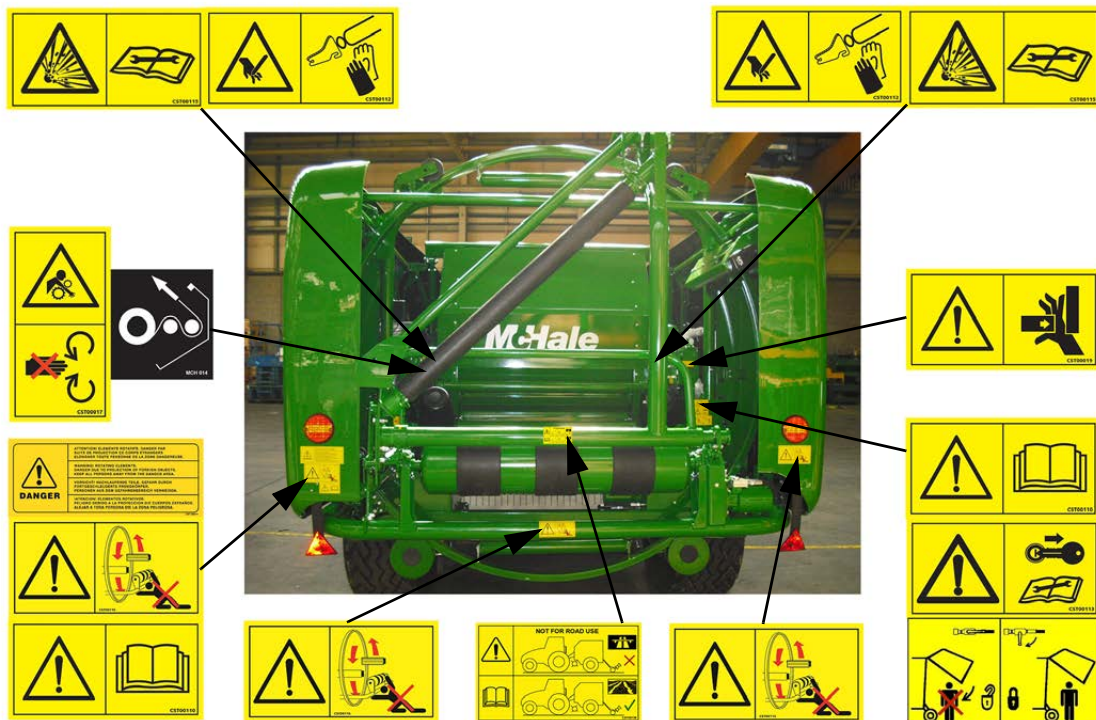

Figure 4.b - Decals on the rear of the Fusion Vario

4.7 Safety warnings & instructions explained

Danger areas which cannot be protected by any devices are marked by yellow safety decals. Therefore it has to be ensured that all safety warnings and instructions are understood and followed. If any of the decals are damaged or missing, they are available from your **McHale** dealer. The relevant part numbers are shown in brackets.

The decals featured on the **McHale Fusion Vario** are displayed with their meanings below:

	<p>Free flow return to tank (CST00006)</p>
	<p>Danger of rotating parts, foreign objects Keep clear of machine while working (CST00014)</p>
	<p>Keep hands clear of rotating rollers (CTS00017)</p>
	<p>Keep hands out of crush area (CST00019)</p>
	<p>Check wheel nuts daily (CST00020)</p>

McHale Fusion Vario Baler & Wrapper



Diagram of plastic film path through dispenser
(CST00022)



Lifting hook location
(CST00032)



Do not dismantle
High pressure always
(CST00056)



Grease daily
(CST00060)



Do not stand on the platform or elsewhere on the machine when the machine is moving or working
(CST00107)



Keep clear of pickup area as long as the engine is running and the PTO shaft is connected to the tractor
(CST00108)



Read instruction manual before use
(CST00110)

McHale Fusion Vario Baler & Wrapper

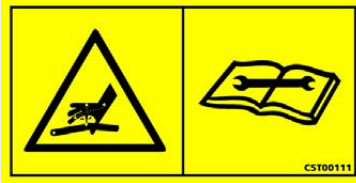

Beware of high-pressure hoses, even when the machine is switched off
Also, read and understand manual before working on any part of the hydraulic system
(CST00111)

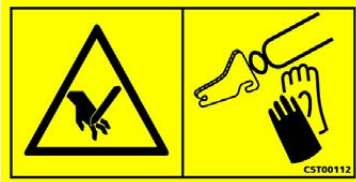

Knives of the cutting device should only be removed with an appropriate tool and protective gloves
(CST00112)



Turn off and remove key from tractor
Read and understand the manual before working on or performing maintenance on the machine
(CST00113)



Close protective covers before operating the machine
(CST00114)



Hydraulic accumulator is under high pressure
Slowly release hydraulic pressure before carrying out any maintenance
(CST00115)

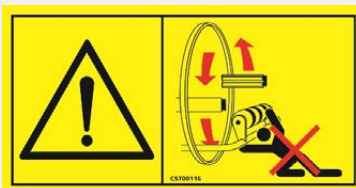

Beware of rotating dispensers, ring and moving wrapping table rollers
(CST000116)



Knife release lever:
horizontal position-locked
vertical position-unlocked
(CST00118)



Keep hands out of the crush area between the roller and chassis rail
(CST00120)

McHale Fusion Vario Baler & Wrapper



Maximum hydraulic pressure and maximum PTO speed. This machine must not be connected to hydraulic systems with pressure higher than 210 bar (CST00121)



Stay clear of rotating PTO shaft. Never use the machine if the PTO guard is missing or damaged. Entanglement in the rotating drive line can cause serious injury or death. It is important to ensure that the rotating guard on the drive line rotates freely. Always stop the engine and ensure the driveline has stopped before making connections, adjustments or cleaning out PTO driven equipment. (CST00132)



General warnings (CST00134)

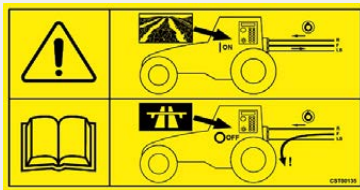

Disconnect the **Fusion Vario** feed line and turn off the control box during road use. Read the operation instruction manual before proceeding. (CST00135)



Dispenser park rotation decal (CST00137)

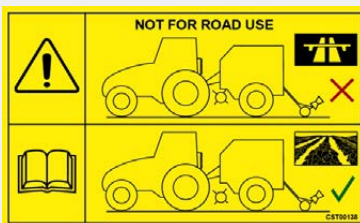

Side Tip: Not for road use (Placed on side tip only) (CST00138)

McHale Fusion Vario Baler & Wrapper



Do not stand in the articulation area while the tractor engine is running.
(CST00141)



Never perform any adjustments or reach into the netter unless the PTO has been disengaged and the tractor has been shut down and the key has been removed. It is also recommended that the tension be released from the netter knife to avoid it being tripped accidentally.
(CST00142)



Stay clear of the rotating PTO shaft. Never use the machine if the PTO guarding is missing or damaged. Entanglement in rotating drive line can cause serious injury or death. It is important to ensure that the rotating guard on the driveline rotates freely. Always stop the engine and ensure that driveline has stopped before making connections, adjustments or cleaning out PTO driven equipment.
(CST00143)



Crush hazard. Keep hands clear of rotating elements. Do not remove the guard while the engine is running.
(CST00144)

McHale Fusion Vario Baler & Wrapper



Disconnect the power supply to the control box and turn off the tractor before commencing work on the electrical system or welding on the machine.
(CST00145)

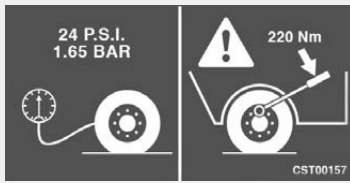

Ensure tyre pressure is at 1.65 bar (24 psi) pressure and torque nuts to 220 Nm.
(CST00157)



Ensure area around brakes is clear of dry material
(CST00163)

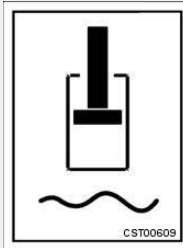

Float decal. Indicating that during operation of the baler, the control lever of the spool operating the pick-up reel should be in the float position.
(CST00609)

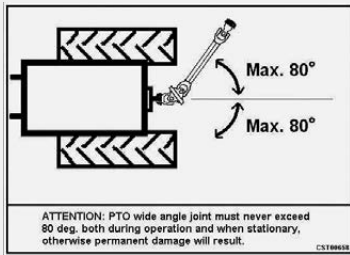

The PTO wide angle joint must never exceed 80 degrees, both when stationary or during operation. Permanent damage may result otherwise.
(CST00658)



Wheel direction
(CST00711)

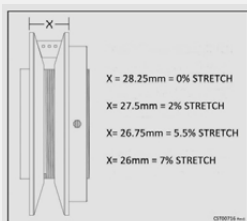

Net tension setting decal. Indicates the settings on the variable pulley for different percentages of stretch
(CST00716)

McHale Fusion Vario Baler & Wrapper



Stop button - Push to Stop! Turn clockwise to reset (CST00758)



Always lock the tailgate in place before working on the open bale chamber. (CST00785)

4.8 Description of the serial number plate

McHale		Tel: 353 (0) 94-9520300		CE
Castlebar Rd, Ballinrobe, Co. Mayo, Ireland.		Fax: 353 (0) 94-9520356		
		Email: sales@mchale.net		
		Web: www.mchale.net		
SERIAL NUMBER	_____ a.	MAX. GROSS WEIGHT @ 10 km/h	7,900 kg	g.
YEAR OF MANUFACTURE	201_ b.	NET WEIGHT	5,800 kg	h.
MODEL	FUSION VARIO c.	MAX. AXLELOAD @ MAX. ROAD SPEED	4,900 kg	i.
MAX. VERTICAL DRAWBAR LOAD	19,000 N d.	VEHICLE WIDTH*	2.76 m*/2.94 m*	j.
MAX. HORIZONTAL DRAWBAR LOAD	135,000 N e.	VEHICLE HEIGHT	3.02 m	k.
MAX. ROAD SPEED	40 km/h f.	VEHICLE LENGTH*	5.8 m* 7.5 m*	l.

The following is a description of the serial plate meanings:

- a. Serial number of the machine
- b. Year of manufacture of the machine
- c. Model name/Number of the machine
- d. Maximum vertical drawbar load (Newton's)
- e. Maximum horizontal drawbar load (Newton's)
- f. Maximum road speed (kilometres per hour)
- g. Maximum gross weight at 10 kilometres per hour
- h. Net weight of the machine
- i. Maximum axle load at maximum road speed of 40 kilometres per hour
- j. Vehicle width: with standard size tyres / optional specification tyres
- k. Vehicle height (metres)
- l. Vehicle length (metres) with no rear attachments / with side tip attachment

4.9 Machine lifting guidelines



WARNING: Machine lifting

- Only use chains or strapping that are rated for a minimum load of two tonnes (2,000 kg) per chain or strap when using the four lift eye locations on the chassis, shown below
- The crane or lifting device must be capable of lifting a minimum load of eight tonnes (8,000 kg).
- Never go under a suspended machine or attempt to try and stop it if moving erratically, death or serious injury may result
- Always be observant of people and objects around the suspended machine and do not allow the machine to impact heavily on the ground after suspension or movement



RHS lift hook

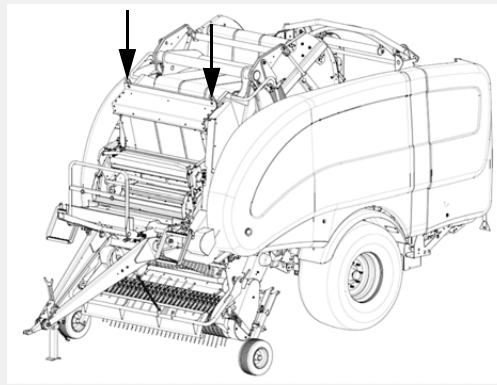

Front left view



LHS lift hook



LHS lift hook

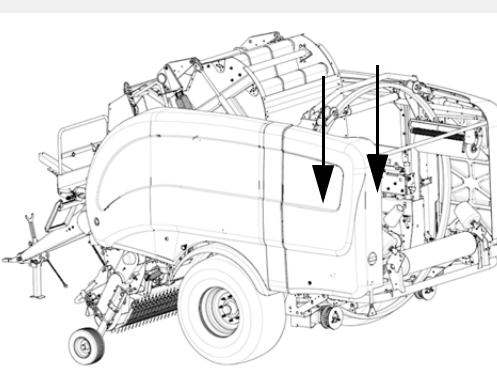

Rear left view



RHS lift hook

5

Tractor requirements & preparation

5.1 Tractor requirements

The minimum recommended size of tractor for operating the **McHale Fusion Vario** comfortably depends mainly on the crop condition and the required cut length of the forage. On flat ground **McHale** recommends a tractor size of approximately 85 kw. On hilly ground or difficult conditions, an additional 10 to 15 kw is advisable.

Ideally the tractor should have a load sensing hydraulic system, as the **McHale Fusion Vario** works at it's best in this setup. Please refer to "Machine set-up & the tractor hydraulic system" on page 34 and "Which hydraulic system is used?" on page 35 for correct selection of hydraulic setup.



NOTE: Use good quality oil

Ensure that the tractor has clean, good quality oil, hydraulic/universal oil to avoid problems later on. Also, the hydraulic filters on the tractor should be changed regularly, according to the manufacturers service instructions. Avoid dirt getting into the hydraulic couplings.

The following items on the tractor are required for attachment of the baler wrapper combination behind the tractor:

1. Low/high drawbar hitch* that is suitable for an imposed load of minimum 7,000 kg
2. One ½" - female quick release single acting, with "float position" for pickup reel
3. One ¾" - female quick release for hydraulic power supply of minimum 45 litres per min @ 180 bar
4. One ¾" - male quick release for return line (Must be free flow to tank)
5. One ⅜" - female quick release for load sensing (Only required if tractor has a load-sensing hydraulic system)
6. One 12 V / 7 pin socket for lighting
7. One 12 V, 20 Amp euro socket or battery power cable
8. One hydraulic brake coupling or two air brake couplings
9. A 1 ⅜", 6 spline PTO shaft (set to a speed of 540 rpm)
10. One secure attaching point to tie the 'break-away-brake' rope to the tractor

* Depending on country of use

5.2 Control box installation

The electronic control box must be located inside the tractor cab in the operator's field of vision and within easy reach of the red emergency stop button. Ensure that the cable to the machine is not under tension and not near sharp edges, etc. The electric power supply is obtained from the euro socket of the tractor.

Connect the supplied fused electric power lead to the tractor battery ensuring to route away from sharp edges and hot surfaces. The control box is not waterproof, it must be protected from rain. See "Control box functions" on page 57.



CAUTION: Electrical power supply

Do not use any other electric power supply for the electronic control system, otherwise damage may occur.

5.3 Attaching to drawbar

The drawbar is to be attached so that the **McHale Fusion Vario** is horizontal to the ground as in "Drawbar adjustment" on page 53. Machines are set up for hitching to the tractor drawbar as shown in Figure 5.a below. Once the tractor is attached to the drawbar, attach the PTO shaft. Depending on the country of use a safety chain may also be required. Detach in reverse order of attachment.



Figure 5.a - Drawbar attachment

5.4 Attaching 'break-away' brake

The **McHale Fusion Vario** is fitted with a hand brake which must be applied when the machine is detached from the tractor. The hand brake handle has a rope fitted to a calibrated ring which must have the other end securely fixed to the tractor each time the machine is attached to the tractor. Should the machine hitch ever become detached from the tractor, this rope will apply the brakes on the **Fusion Vario**.

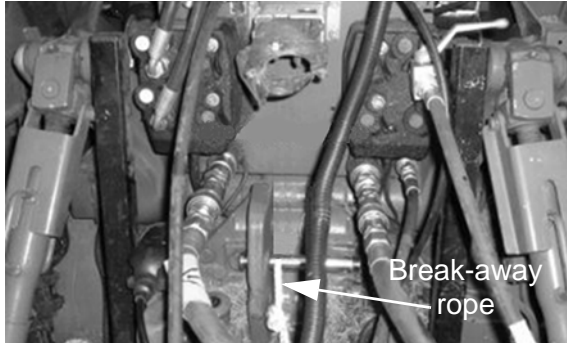

Figure 5.b - Break away rope fixed to tractor



Figure 5.c - Handbrake handle



CAUTION: Release hand brake

Always ensure the hand brake has been released before moving the **Fusion Vario** on the road or operating in a field.

5.5 Attaching the machine to a 540 rpm PTO

All mechanical functions are related to the correct PTO speed. Follow the instructions as supplied with the PTO unit for correct assembling of the PTO shaft to the tractor (See "PTO shaft adjustment & maintenance" on page 54). Ensure PTO cover-guards are prevented from rotating, by securing the chain to the tractor.



CAUTION: Standard PTO of 540 rpm, maximum = 610 rpm

The **McHale Fusion Vario** should be driven with a standard PTO speed of 540 rpm. The maximum PTO speed allowed = 610 rpm. A PTO speed above 610 rpm is likely to cause damage to machine components. Do not use any faster PTO speed other than specified above!

5.6 Lighting system

The 7 pin plug of the lighting system on the machine must be connected to the 7 pin socket on the tractor.



NOTE: Check lighting system before travelling on the road

Before travelling on a public road, the operator must ensure that the complete (tractor and machine) lighting system is in a fully functioning condition.

5.7 Machine set-up & the tractor hydraulic system



CAUTION: Hydraulic system setup

It is very important to determine the correct hydraulic system on the tractor, as a wrong set-up will cause serious damage to the tractor hydraulic system, or at least excessive heating of the oil.

There are 3 systems found on tractors, as outlined below:

- 1. Open centre:** This is the most common system on smaller tractors (less than 60 kw) and also on some bigger older tractors. In this system, all the oil flows through the control valve, when the machine is idle. The tractor will have a fixed displacement pump and the output flow will be max. 60 litres/min and flow is usually not adjustable.
- 2. Closed centre:** Although not so common on today's tractors, this system is still found on the older John Deere models (pre. 00 & 10 series), but also on some other makes and particular models. In this system, no oil flows through the control valve, when the machine is idle, but maintains max. oil pressure in the feed line. The tractor will have a fixed displacement pump and the output flow is usually not adjustable.
- 3. Load sensing with "Power Beyond" fitted:** This is, by far, the preferred system. Most newer tractors are done this way, but not all. In this system, no oil flows through the control valve, when the machine is idle, but it maintains a low oil pressure in the feed line, (approx. 21 bar). The tractor will have a variable displacement pump and will always have some means of adjusting the oil flow on each auxiliary valve.

In it's most ideal configuration, the tractor will have a "Power Beyond" connection, i.e. oil comes direct from the pump, by-passing the tractor auxiliary valves, to a 'Female ¾" Quick Release' connection, which becomes the **Fusion Vario** feed.

It will also have a 3rd connection to the tractor, called the pilot sensing line, and this pipe sets the correct oil flow for the tractor to pump for each operation.

This is the most advanced and efficient hydraulic system available, as the control valve now controls the amount & pressure of oil required for each control valve operation, and only the correct amount is pumped. This will save up to 20 kw PTO power on the tractor.

Although it is possible to operate the **Fusion Vario** with a load-sensing system via the tractor auxiliary spools, i.e. continuous oil flow (control valve is set to open centre set-up and flow is set to 45 litres/min from the tractor). **McHale** do not recommend operating the machine in this set-up, as controlling the oil flow is too variable from one tractor to another, and there is also a 20 kw PTO power loss with it's associated over-heating of the oil.

Once the correct tractor system is identified, use the map in the next section, to select the best set-up for the **Fusion Vario**.

5.8 Which hydraulic system is used?

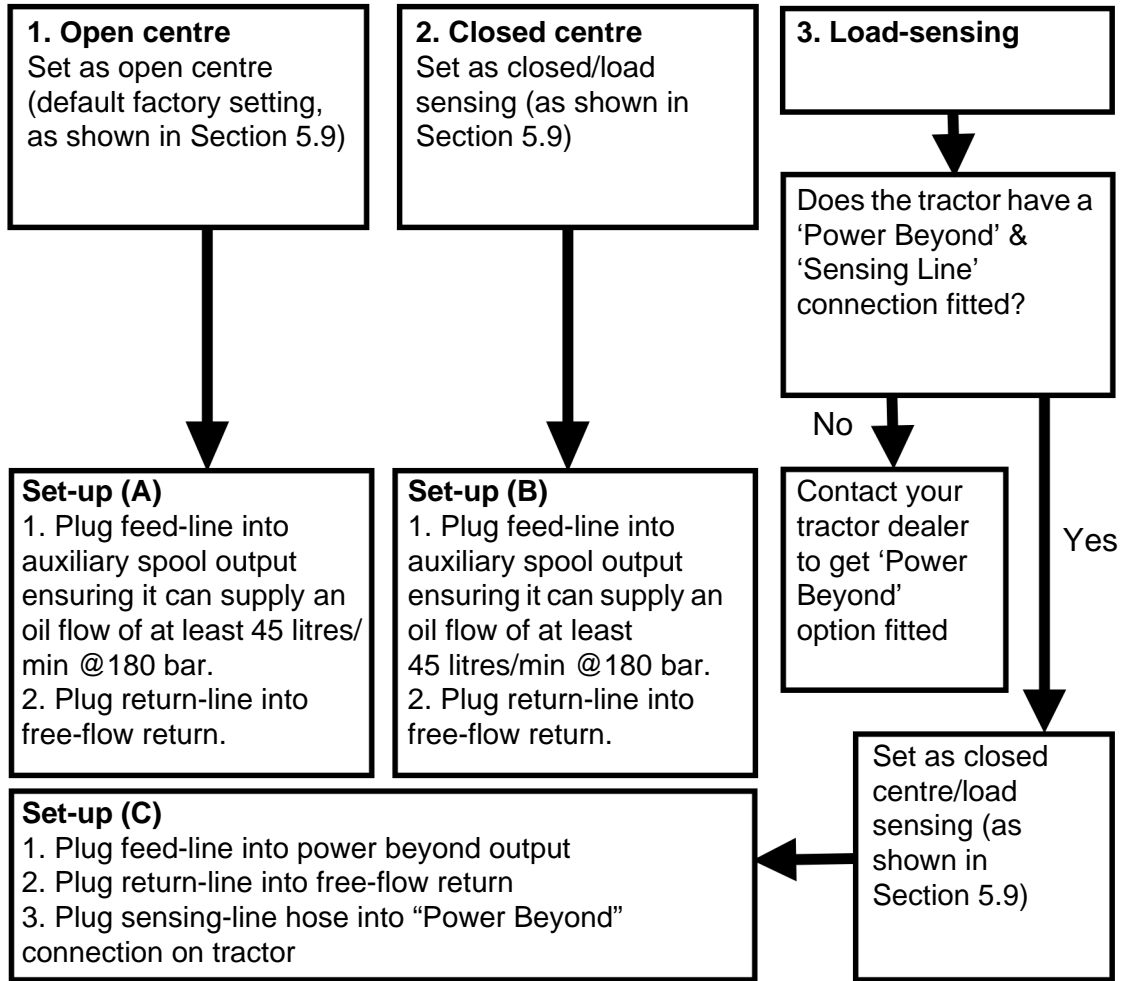

5.9 Hydraulic spool valve setup

Procedure to select open/closed-centre valve configuration:

1. Using a 17 mm spanner, loosen locknut (1) as shown below
2. With a 4 mm Allen key, tighten or unscrew the bolt (2) according to the following guidelines:
 - (a) Open centre (factory default): Screw in fully (Do not overtighten)
Tightening torque = 6.0 Nm
 - (b) Closed centre/load sensing: Unscrew 5 full turns from the fully in position
3. Re-tighten 17 mm locknut. Tightening Torque = 20 Nm

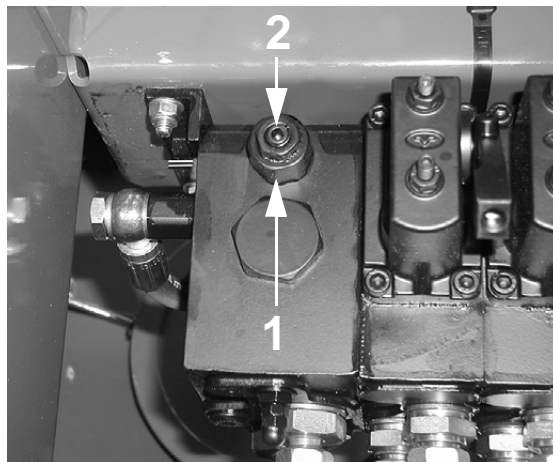

Figure 5.d - Hydraulic spool valve setup

5.10 Attaching hydraulic hosing to the tractor



WARNING: Turn off tractor and remove key before connecting hydraulic hosing

When connecting hydraulic hosing to the tractor, ensure that the tractor engine is turned off and that the ignition key is removed. Ensure that all hydraulic connections are correctly tightened.

There are a total of five hydraulic hoses (four on air brake models)* and three electrical connections that must be connected to the tractor. They are as follows:

1. One $\frac{3}{4}$ " female quick release for return line. It must be noted that the return line must have a free flow to the tank. (Where a $\frac{3}{4}$ " coupling is not available on the tractor, a special $\frac{1}{2}$ " male quick release is supplied with the **Fusion Vario** in the toolbox and should be used to replace the $\frac{3}{4}$ " coupling fitted)
2. One $\frac{3}{4}$ " male quick release for feed line (Where a $\frac{3}{4}$ " coupling is not available on the tractor, a special $\frac{1}{2}$ " male quick release is supplied with the **Fusion Vario** in the toolbox and should be used to replace the $\frac{3}{4}$ " coupling fitted)
3. One $\frac{3}{8}$ " male quick release for load sensing (if tractor is load-sensing)
4. One $\frac{1}{2}$ " male quick release for pickup reel (with on-off tap)
5. One hydraulic brake coupling *
6. One 12 V / 7 pin lighting socket

McHale Fusion Vario Baler & Wrapper

7. One 12 V, 20 Amp euro socket (Machine loom to control box shown)
 8. One break away rope fixed securely to the tractor
- * In the case of air brakes, there must be two air brake couplings available*

See the following figure for possible piping layout. Ensure that the machine operator is familiar with all tractor connections and fittings.

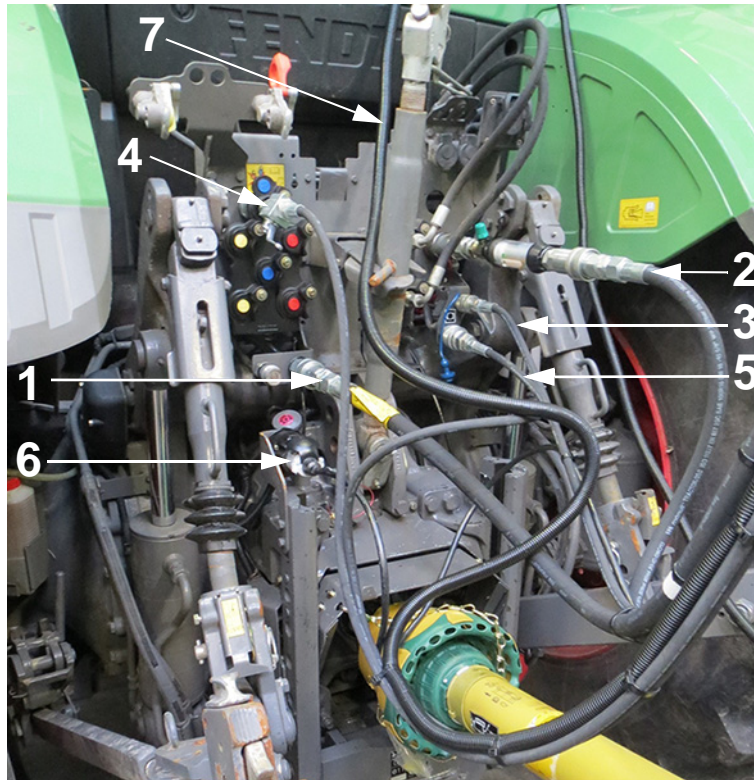

Figure 5.e - Possible layout of hydraulic hoses and electric looms

5.11 Connecting the control box

The control box is to be connected to a 12 V, 20 Amp power supply either using the supplied euro socket or the battery power cable. A good power supply is critical for proper machine operation as the electronic control box is the main interface between the operator and the machine.



CAUTION: Do not connect control box to a 24 V power supply

Do not attempt to connect control box to a 24 V power supply, as machine component damage will result.

6

Baler requirements & preparation

6.1 Net requirements

In order for the **McHale Fusion Vario** to produce well-shaped bales of excellent density, a top quality net, that is as similar as possible to the specification recommended below, should be used. It is of the utmost importance that the net is used and stored according to the instructions of the net manufacturer.



NOTE: Minimum turns of net recommended

For netting silage, a minimum of two layers of net is recommended. When the material is drier, the netting amount should be increased to four or more turns. A general rule to follow is to apply the amount of net that will maintain the bale size.

McHale recommend the use of a net roll which meets the following specifications:

- Material: High quality, high density polyethylene
- Density: Minimum of 10 g/m \pm 10%
- Elongation: 15% \pm 3%
- Strength (in direction of wrap): 900 N/500 mm
- Material Length: 2,000 - 4,000 m \pm 200 m
- Material Width (ideal): 1,230 mm (Max. 1,260 mm)



ENVIRONMENT: Recycling of the net roll

Respect the environment! Never throw away or burn the waste net and the core tube. Always take waste materials to a recycling centre.

6.2 Care of the net roll

The net roll should be protected from damage and moisture. Do not remove protective cover until ready for use. Net damage can cause undesired netter performance and affect bale weatherability.

6.3 Care of the net wrapping system

Before operating the baler, ensure that the following procedure is followed to ensure improved netter operation:

- Clean off rubber and metal feed rollers and check for any tacky material
- Once roller cleaning is carried out, ensure to apply talcum powder to the rubber feed roll



NOTE: Cleaning solvents

Never use cleaning agents such as benzene, petrol, turpentine oil or similar cleaning solvents to clean rubber feed roll, otherwise damage may occur!

McHale recommend using either of the following:

- A cloth soaked in dish washing liquid
- Soapy water

6.4 Loading & operating the netter system



WARNING: Lifting full net rolls

Pay attention to the heavy weight of the net roll. It is recommended that full net rolls should be handled by two people.

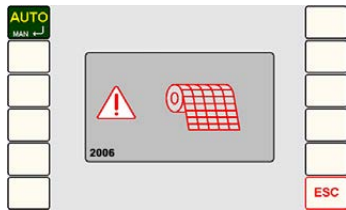

The passage of net through the netting unit is monitored; if the net breaks or does not feed, or if the roll of net runs out, then the alarm sounds, the **net error symbol** is displayed in the control box display and the cycle is halted (See Section “Net settings” on page 68).

The following is the procedure for changing a roll or fitting the first roll:



1. **CAUTION:** Ensure that the PTO and the control box are turned off before loading or adjusting the netter unit.

Slide the new roll of net onto the net storage space on the platform

NOTE: Ensure that the roll is orientated in the correct direction.

McHale Fusion Vario Baler & Wrapper

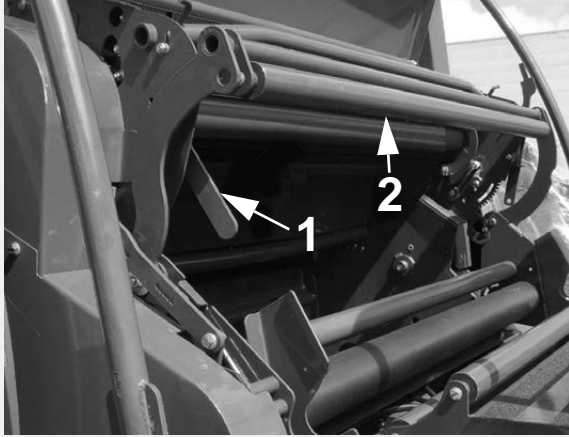

2. Press the feed roller tension release lever (1) down until it locks in the fully lowered position. This will spread the feed rollers on the net feeding unit.

Lift the net roll brake bar (2) upwards until it locks in the raised position.



3. Pull approximately 1.5 metres of net off the roll and thread it through the net tension rollers as shown.

NOTE: There are two options for threading the net through the net tension rollers.

Option A - Used for high quality/high strength nets.

Option B - Used for lower quality/lower strength nets.

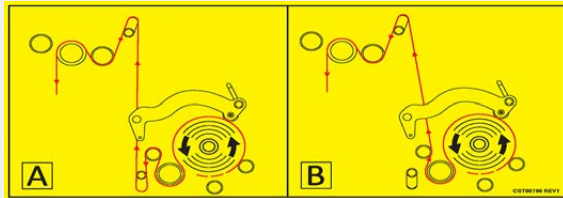

4. Thread the net through the net tension rollers and the net feed rollers as shown here in CST00786.

Ensure the net is threaded correctly through the net tension rollers. This is dependant on the quality of net being used, whether to choose Option A or Option B.

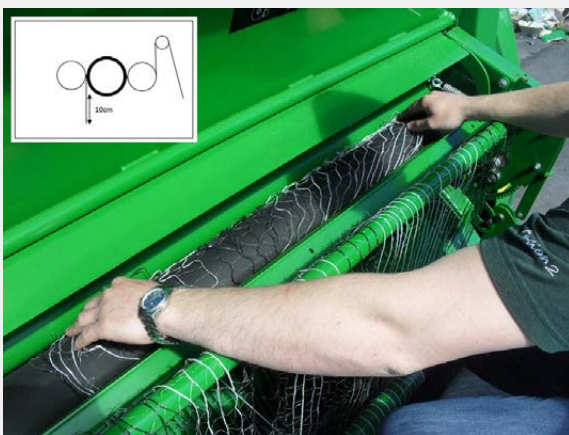

5. Spread the net across the rubber feed roller as shown. Roll the feed roller forward, to feed the net into the netter.

NOTE: the net should only be fed in to a maximum of 10cm past the rubber feed roller.

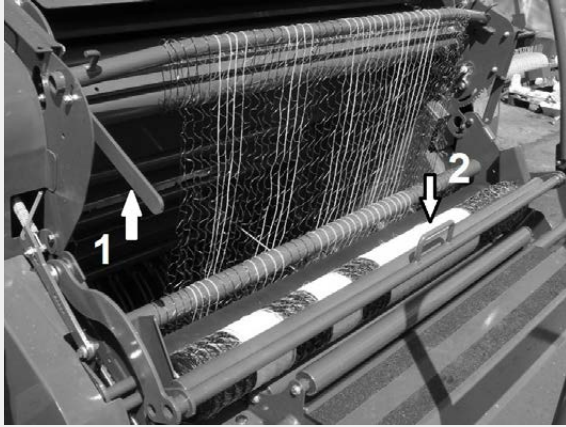

6. Lower the net roll brake bar (2) down onto the roll and then release the roller tension lever (1) by pulling upwards, which will compress the three net rollers together.

CAUTION: The brake bar and feed rollers are under spring pressure. Ensure hands and feet are clear before releasing.

The roll of net is now threaded and ready for baling.

6.5 Net layer adjustment setting

In an automatic cycle, the netter starts feeding net once the set bale diameter has been reached. After a number of pulses have occurred the net feed arm is released, the net is introduced to the baling chamber and the bale catches the net. The bale is then wrapped with the predetermined net length.

The amount of net applied can be adjusted between 1.1 and 6.0 layers per bale, using the control box (See Section “Net settings” on page 68). It is recommended that a minimum of two (2) layers of net are applied to the bale. Dry conditions and very high densities require up to four (4) or more layers to ensure a good bale shape. The net feed arm will reset to the baling (working) position when the tailgate is opened to release the bale.

If the net is not caught by the bale on the first attempt, the netting cycle can be repeated by pressing and holding Button L3 (See “Control box functions” on page 57) for 3 seconds.



NOTE: Hay or straw with a high dry matter needs more net

When the control box is set to “Bale only”, for hay or straw being baled with high percentage dry matter, more net must be applied.



CAUTION: Adjusting the net cutter

Never attempt to adjust the net cutter setting until the knife has tripped.

McHale Fusion Vario Baler & Wrapper

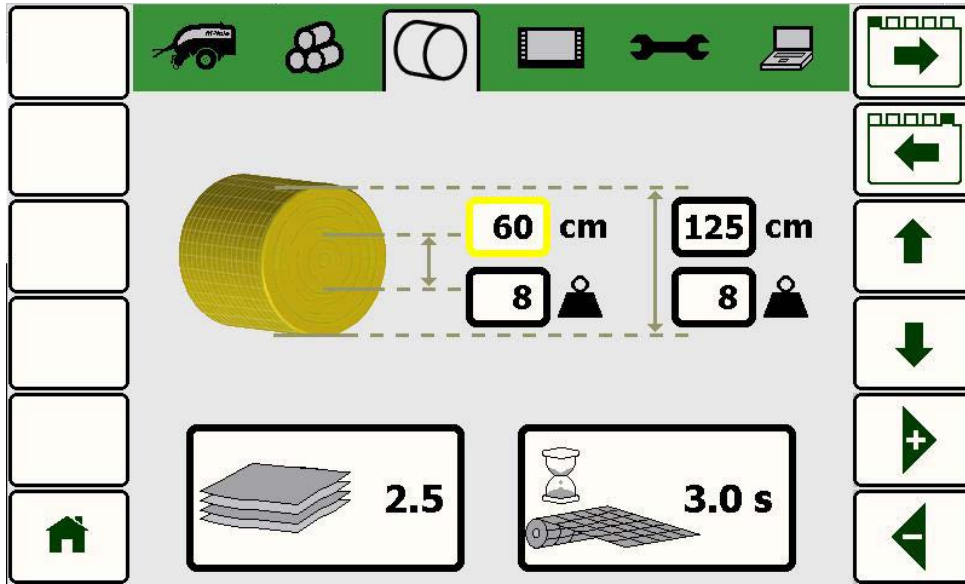

Once set, the number of net-layers is automatically calculated, regardless of bale diameter or size.

In manual mode, the net is fed, by pushing and holding Button L3 until the bale catches the net. The operator then cuts the net by pushing and holding button L4 until the netter knife trips, otherwise net will continue to feed until Button L4 is activated.

To repeat the netting cycle in manual mode the chamber closed button (R2) must be pressed to return the net feed arm to the baling position, then button L3 can then be pressed to repeat the netting cycle.

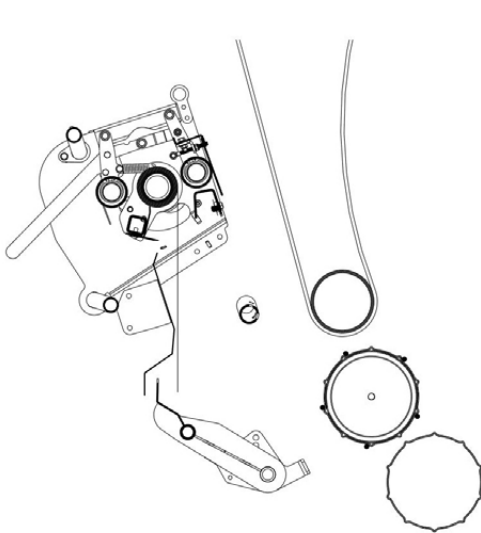

Figure 6.a - Baling position

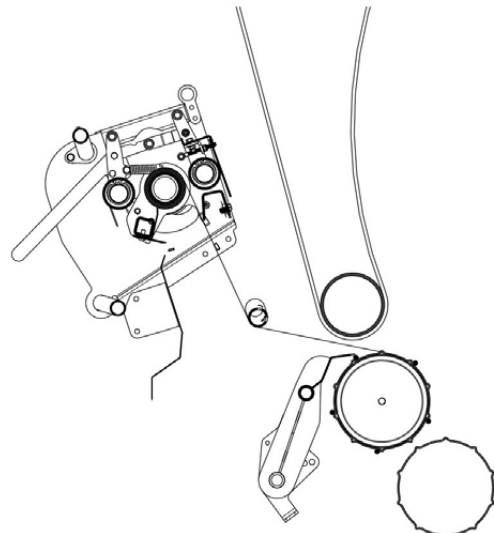

Figure 6.b - Netting position

6.6 Chopper unit knife removal & installation



WARNING: Incorrectly installed knives can cause irreparable damage

Incorrectly installed knives can cause irreparable damage to both the knives and the rotor, leading to serious destruction within the machine!



CAUTION: Use protective gloves

Use protective gloves for any manual work in this area! The number of knives installed, determines the cut length of the material.

Knife installation/removal should be carried out in the following way:

1. Ensure the knives are in the UP/ON position, before beginning
2. Lower chopper unit floor half way. (Control box must be in manual mode) Press 'Lower floor' button (R2) for one to two seconds approximately.
3. Open the tail gate fully.
4. Lock the tail gate in position, using the lever valve (A), by pulling forward and rotating it down 90° to the left vertical position as shown.



5. Shut down tractor, remove key, apply parking brake and prevent any machine movement by using wheel chocks.
6. The knife lock /unlock lever (B), is located on the left hand side of the chopper unit just behind the pick up reel. It must be pulled outwards at first, to disengage from the lock-pin, then turned 90° downwards, to the unlock position, as shown below. Reverse this procedure to return to the 'locked' position.

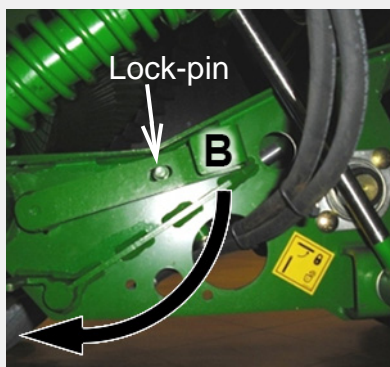

Locked 'Closed' Position



Unlocked 'Open' Position

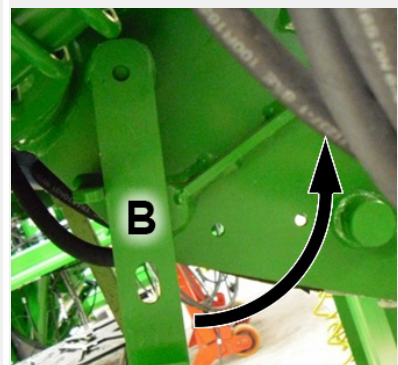

McHale Fusion Vario Baler & Wrapper

7. Removal of knives/blanks is the reverse of the following installation procedure. Pay particular attention to all decal warnings and safety advice.
8. Rotating lever "B" exposes "flats", on the lock-shaft which allows either knives or knife-blanks to be added or removed. Remove old knives with a pair of pliers.

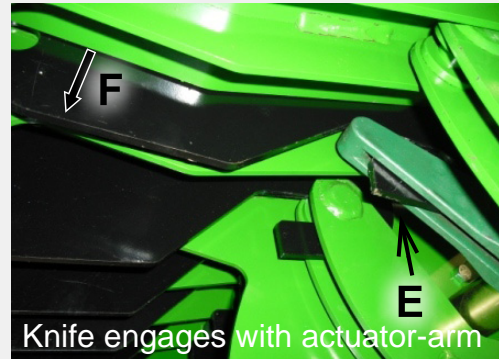
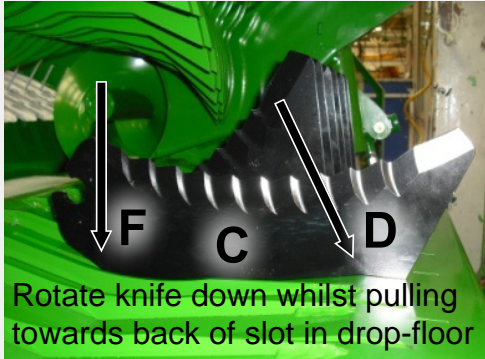

9. A new knife (C) can be installed by inserting into the back of the slot in the drop floor (D), so it engages with "raised" actuator arm (E). Next rotate knife downwards (F) whilst continuing to hold towards back of slot, until front toothed area looks like it will clear front end of slot by 5-10 mm (G), as shown.

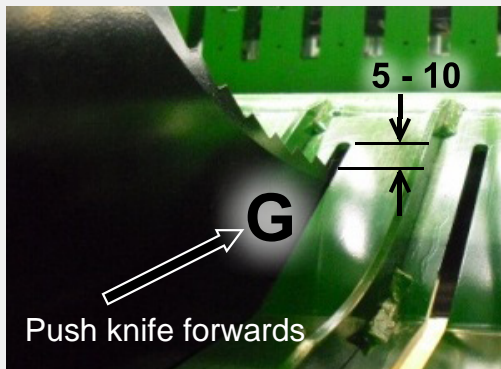

10. Now push knife forwards, continuing to maintain this 5 to 10 mm clearance under front of slot. The keyhole-slot on the front end of the knife should now guide itself over the "flats" of the lock-shaft (H).

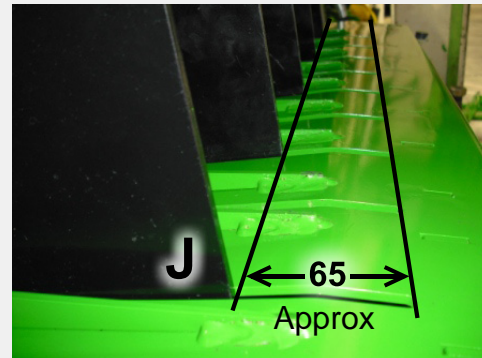
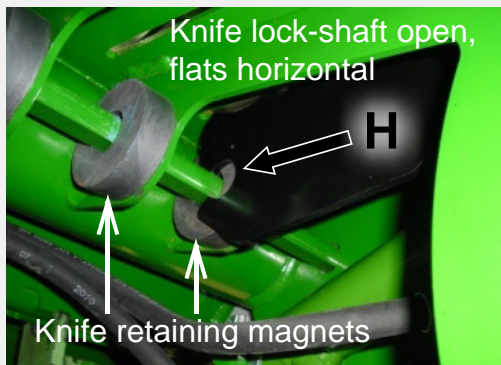

11. Continue to push the knife forward until fully home, which should leave a gap between the knife and back end of slot of approx. 65 mm (J), with maximum protrusion of approx. 190 mm (K) (assuming knife-actuators are fully up). The retaining magnets will hold knives in position until knife lock-shaft is closed.

McHale Fusion Vario Baler & Wrapper

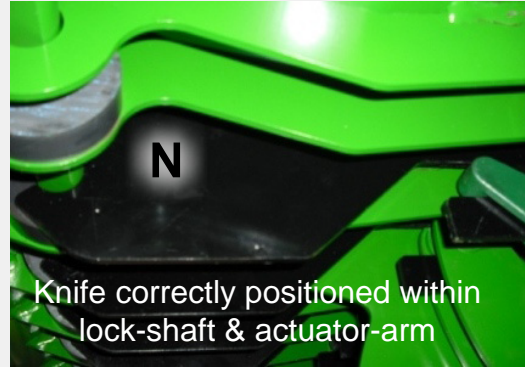
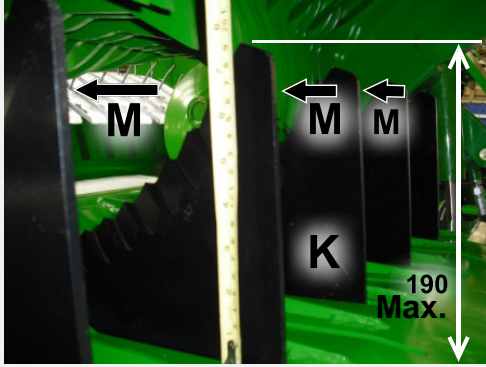

12. After installing, push the top of each knife forward as shown, in the direction of the arrow (M), to ensure proper engagement within both lock-shaft and actuator-arm. If the knife moves, then it is not positioned correctly. The correct position is shown at (N).

13. If knives are removed, for whatever reason, always replace with knife blanks to prevent crop catching in the “open” slots. These are stored in the knife holster. See “Knives/blanks storage” on page 46.

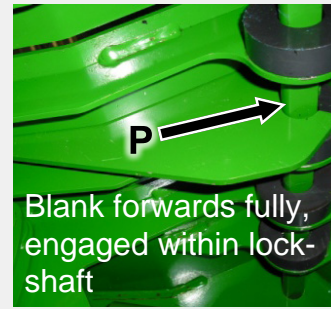
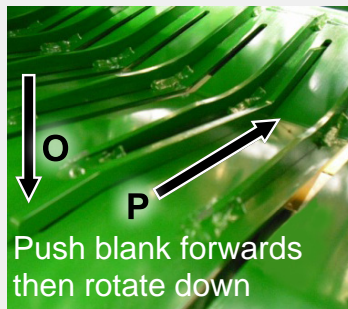
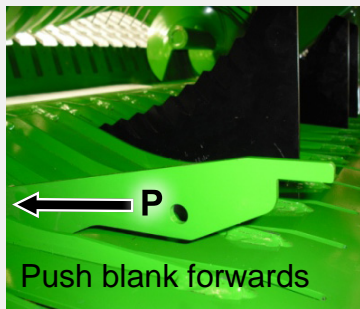

14. Installation is simpler, in that they only engage with the lock-shaft in front and not with the actuator-arm. The knife-blank is dropped into slot towards front, again maintaining the 5 to 10 mm gap (G), push forward (P), allowing the keyhole-slot to engage with lock-shaft. Then rotate downwards (O) and push forward fully.

15. Always observe the row of knives after installation. They should all be perfectly aligned and at the exact same height. If one or more do not line up, then they are not correctly positioned. Typically the lowest and furthest forward are correct.

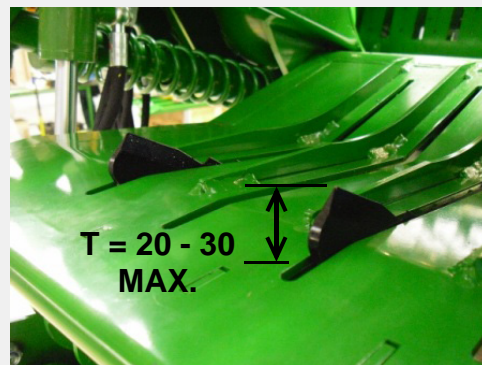
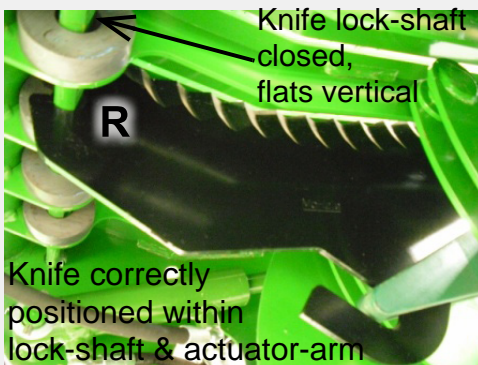

16. Here the knives are shown fully down/retracted, with lock-shaft returned to the “locked” position (R). Knife tips should protrude 20 to 30 mm maximum (T).

17. Rotating lever B back up to 90° onto lock-pin, locks all knives/blanks securely.
18. The knife blanks are stored in the knife/knife blank holster which is located at the front left of the **Fusion Vario**. They are to be used any time one or more knives are removed.



WARNING: Turn the levers back into their working position

Do not forget to turn the levers back into their working position(s), but only after completing all work on the machine as shown.



WARNING: Compartment doors panels must be closed while the machine is running - danger of rotating components

Always keep the compartment door panels closed while the machine is running because of the danger of rotating components! Take note of all warning decals and ensure that all safety measures and precautions are implemented before attempting to carry out any maintenance work.

6.6.1 Knives/blanks storage

The knife blank holster has two methods of retention, L and S, as shown in Figure 6.c. Upper pin L can be pulled out from the left by first removing the linch-pin on the right. The lower pin S is used as a clamping device, to prevent knives/blanks from vibrating and can be loosened by turning anti-clockwise and tightened by turning clockwise.

Removal of knives/blanks is the reverse of the installation procedure. Pay particular attention to all decal warnings and safety advice.

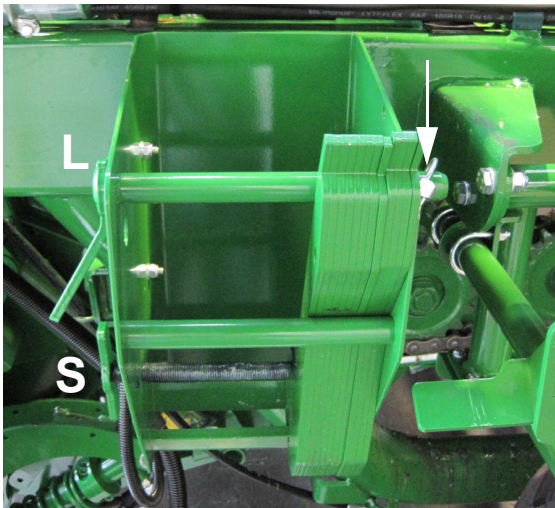

Figure 6.c - Knives/blanks storage



Figure 6.d - Knife blank

6.6.2 Knife sharpening

The knives in the chopper unit should be sharpened on the flat side using either a file or a mopping disk. The knife should never become hot while sharpening, otherwise it will lose its tensile. (Sharpen along the flat edge on this side only)

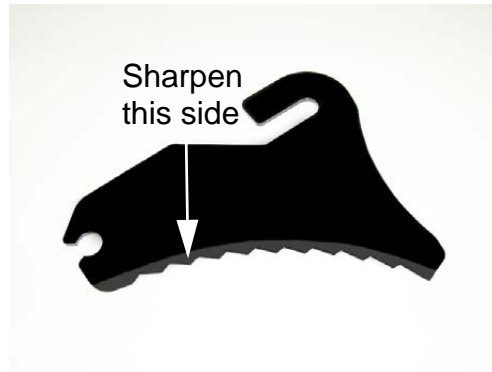

WARNING: Never use a grinding disk

Never use a grinding disk when sharpening the knives.

6.7 Automatic lubrication system

The **McHale Fusion Vario** is equipped with a fully automatic oiling system which is responsible for oiling of all chain systems. All grease points must be greased, as specified in "Machine maintenance" on page 114.

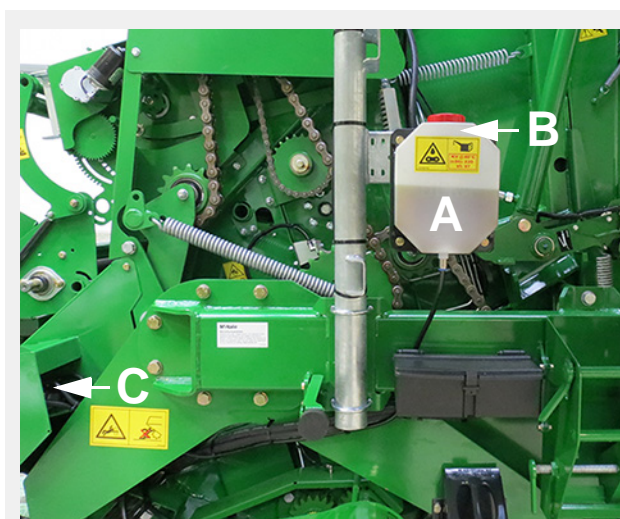

- A. Oil reservoir tank
- B. Oil strainer
- C. Oil pump

Figure 6.e - Oil reservoir tank and pump

The oil reservoir tank (A) can hold approximately 3 litres of oil and this is enough oil for approximately 12 working hours. It should be kept between the minimum and maximum markings at all times. **McHale** recommend the use of only top quality chain oil and grease, this will prolong the life of the machine components.



WARNING: Ensure the tractor is shut down before adding oil

Ensure that the tractor engine has been shut down, the key has been removed from the ignition and the brakes have been applied before adding oil.

To add oil:

1. Unscrew the top cap and add chain oil to the oil reservoir tank (A), up to the maximum level mark shown.
2. Replace the cap and tighten fully.



NOTE: Oil filter needs to be replaced at least once every season

The oil filter, inside the oil reservoir tank, will need replacement once every season or as soon as reduced oil consumption is noticed. The filter is critical to proper operation and lubrication.

6.8 Greasing

The **McHale Fusion Vario** is equipped with a manual greasing system.

The majority of the balers greasing points are greased from two centralised blocks, one on either side of the machine. (See figures 6.f & 6.g)

These serve the bearings on:

1. the chamber rollers
2. the rotor
3. the pick-up drive gears
4. hinge pivot points
5. tension-arm pivot points

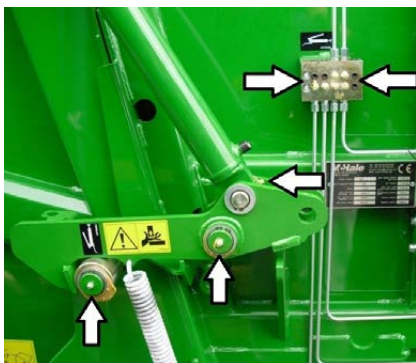

Figure 6.f - Grease block NDS



Figure 6.g - Grease block DS

Above figures show several additional grease points, like door hooks, which are not served from the central greasing blocks and must also be greased separately. These points should be greased on a daily basis.

McHale Fusion Vario Baler & Wrapper

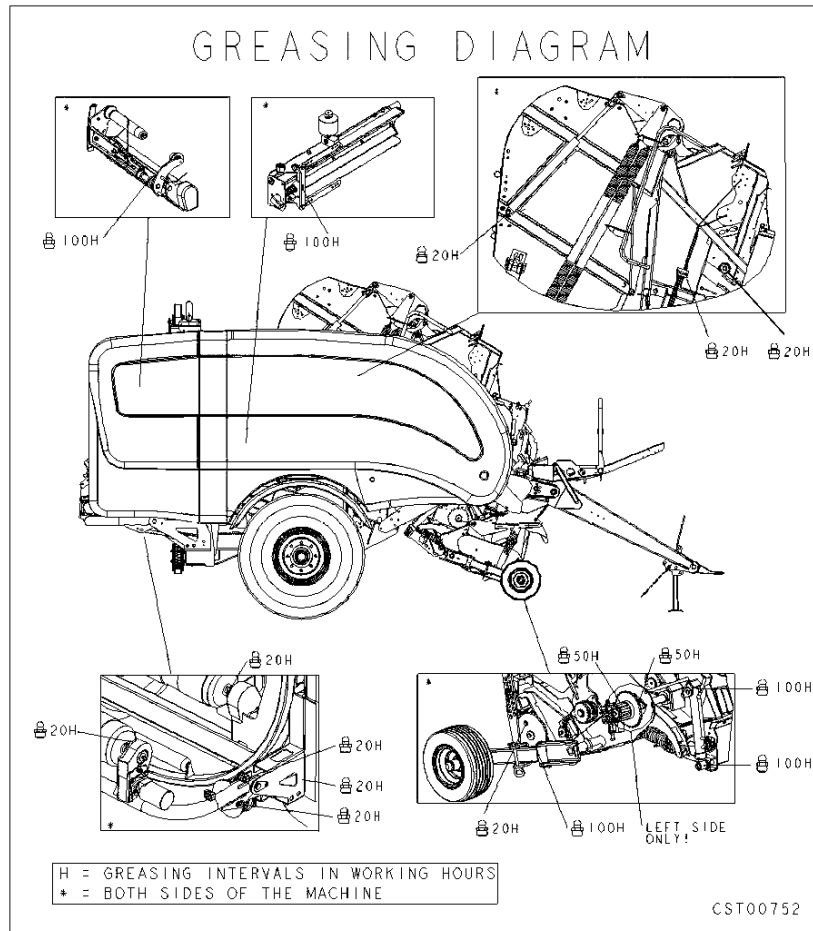

Figure 6.h - Greasing Diagram

The above instructions only cover the main components that must be greased daily (250 bales). Please refer to “Machine maintenance” on page 114 to see all greasing points and their associated scheduling as part of the machine maintenance program.

McHale recommend using a Multipurpose, extra high performance grease, this will prolong the life of the machine components.

6.9 Gearbox oil

The gearbox is located to the rear of the PTO shaft.



WARNING: Ensure the tractor is shut down before changing oil

Ensure that the tractor engine has been shut down, the key has been removed from the ignition and the brakes have been applied before changing oil.



NOTE: Oil must be drained & filled after the first 5 hours of use

After the first 5 hours of use, the gear box oil must be completely drained and filled with SAE 80W/90 grade oil.



ENVIRONMENT: Safe disposal of oil

Respect the environment! Never spill oil or grease on the ground, never pour them down the drain and never discard them where they can pollute the environment. Always take waste materials to a recycling centre.

To drain and add oil to the gear box, carry out the following procedure:

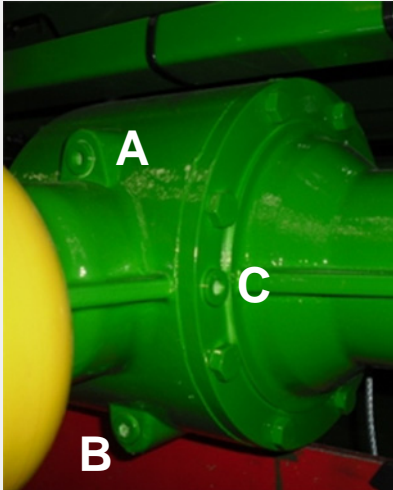

1. Remove the filler plug (A), followed by drain-plug (B), using an 8 mm Allen key and drain oil into a suitable container. This is best carried out while the oil is still warm, i.e. soon after use. Replace the drain plug (B), tighten securely and dispose of waste oil responsibly.
2. Remove the level-plug (C) and add between 2 and 2.2 litres of SAE 80W/90 grade oil, or until oil begins to seep out at C.
3. Replace the level-plug (C) followed by filler-plug (A) and tighten securely.

After this replace the oil once per season or once every 10,000 bales, whichever comes first.



NOTE: Do not overfill the oil

Do not overfill the oil, as this will result in overheating and oil leakage.

6.10 Tyre inflation pressures



CAUTION: Check the tyre pressure weekly

Check the **McHale Fusion Vario** tyres weekly for the pressures outlined in the following table.

Tyre type	Pressure
650/50 R22.5	1.65 bar (24 psi)
170/60 - 8 (Pick-up tyre)	2.07 bar (30 psi)

6.11 Wheel chocks

Wheel chocks are provided to secure the baler wheels anytime the baler is to be detached from the tractor, or if the machine is to be stored or parked up. They are located one on either side of the machine between the pickup and wheel.



Figure 6.i - Wheel chocks (one located on each side of the machine)

6.12 Drawbar and PTO shaft stand usage

There are three types of drawbar stands available on the machine, depending on the country of use, one will come as standard:

1. A swing down fixed length stand (low hitch) - Type A
2. A swing down screw stand (low hitch) - Type B
3. A fixed screw down stand (high hitch) - Type C

The drawbar stands are to be used every time the machine is disconnected from the tractor.



CAUTION: All stands must be rested on a solid footing

All stands must be rested on a solid footing, on level ground and also the supplied wheel chocks must be used.

Type A - The following applies to the swing down fixed length stand (low hitch):

- Transport working position: While using the machine, ensure that the drawbar stand (1) is raised full with stand pin (3) in alternate hole position and ensure PTO shaft stand (2) is in the lowered horizontal position.
- Storage position: Ensure that the stand pin (3) is properly placed in the lower slot to prevent the stand from collapse. Then place PTO shaft stand (2) in an upright position in order to support the PTO shaft (4).

Transport (Working) Position

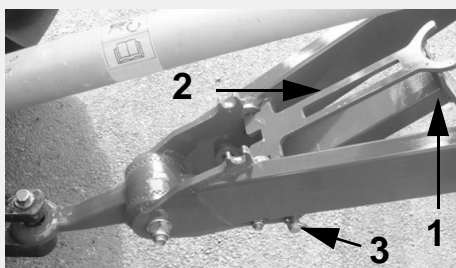

Storage Position

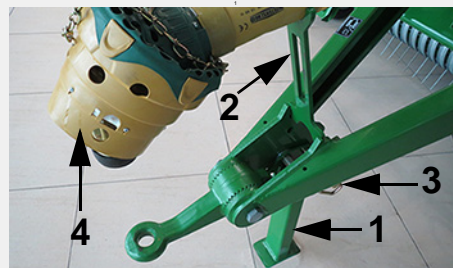

McHale Fusion Vario Baler & Wrapper

Type B - The following applies to swing down screw stand (low hitch):

- Similar to type "A", except stand pin (3) is in the upper slot, in the transport (working) position. It should be wound up and retracted fully as shown before removing the handle. The main difference being, that the drawbar height is now fully adjustable and the PTO shaft stand (5) is an integral part of the assembly.

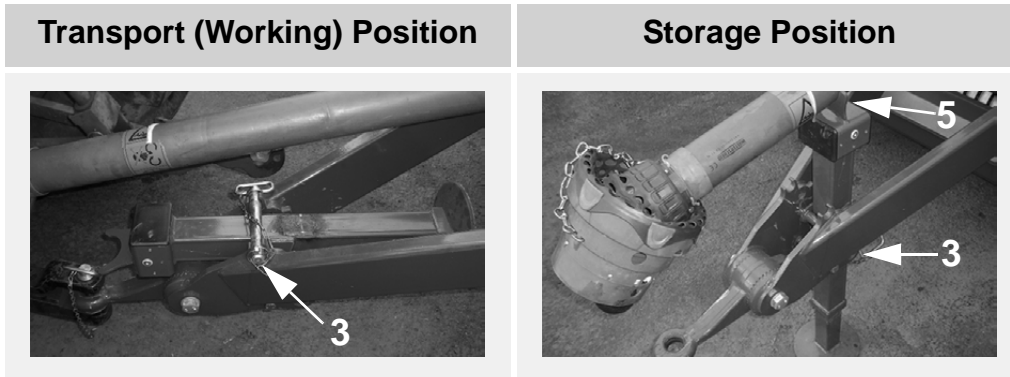

Type C - The following applies to the fixed screw down stand (high hitch):

- Stand type C is the only type supplied with the high drawbar hitch option and is available as an option on the low drawbar hitch machines.
- In order to elevate the drawbar, rotate the jack handle (1) in a clockwise direction as shown in the figure below. In order to lower the drawbar, rotate the handle in a counter-clockwise direction.
- When the drawbar has been safely connected to the hitch on a high hitch style tractor and the machine-weight taken off the stand (by rotating jack handle (1) in a counter-clockwise direction) the lower part of the stand (2) can be retracted quickly by removing the quick-release pin (3) (having first removed the R-clip (4)) and sliding up, the lower part of the stand, fully into position. Align the bottom hole and replace the pin (3) followed by R-clip (4).



- The PTO chain support (5) holds the PTO shaft when disconnected from tractor, in the storage position.
- Depending on the height of the windrow being baled, the stand may need to be elevated further, in order to avoid catching crop. This is done by rotating the jack handle (1) in a counter-clockwise direction until it is fully retracted.

6.13 Drawbar adjustment



WARNING: Adjustment to be completed by qualified persons only

This work should only be carried out by qualified persons or your **McHale** dealer!

This adjustment should be carried out on a level concrete surface, with the tractor drawbar aligned such that the exact adjustment can be monitored. Ensure that the tractor engine has been shut down, the ignition key removed and the brakes applied. The machine handbrake must be applied, the main wheels chocked, with the front end of the machine (under the chopper unit) supported on axle stands. The drawbar should be adjusted so that the machine is level and horizontal to the ground when in the working position, see below. To adjust, first remove the safety bolts, then slacken the hinge bolts (C), but do not remove. The hitch eye can be adjusted to different height positions by repositioning bolts (B) in alternating hole positions. It can then be re-adjusted locally by loosening bolts (A & D) to ensure it is level. Once the desired height is achieved, ensure that bolts (A & B) are tightened to a torque value of 750 Nm and the 30 mm top drawbar hinge bolts (C) tightened to a torque value of 1,500 Nm. Tighten bolt (D) and reposition and tighten safety bolts.



NOTE: The drawbar bolts must be inspected every two weeks

The main drawbar bolts (A & B) along with hinge bolt (C) must be inspected once every two weeks.

Hitch eye

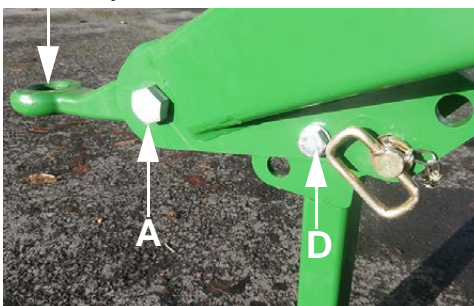

Safety bolt

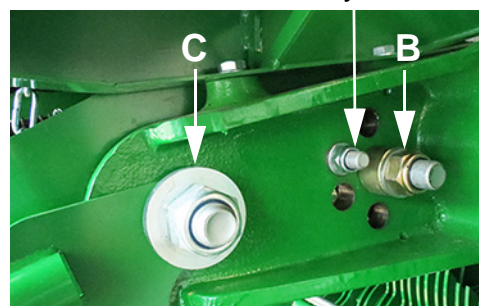

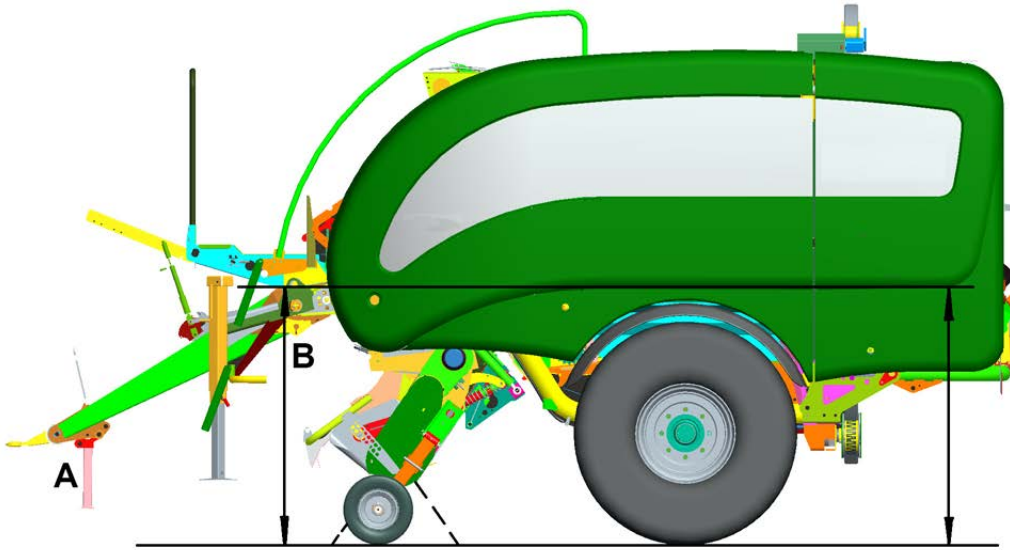

6.14 PTO shaft adjustment & maintenance

The length of the PTO shaft is suitable for all known tractor conditions. However, before the machine is operated for the first time with a new tractor combination, it must be ensured that there is a minimum sliding clearance of 200 mm left during all angles between the tractor and the machine. In a case where there is not sufficient sliding clearance the shaft length must be adjusted according to the PTO shaft manufacturer's recommendations that are either attached to the PTO shaft or included with this manual or both. Maximum 80° angle of movement should never be exceeded, otherwise permanent damage will result.

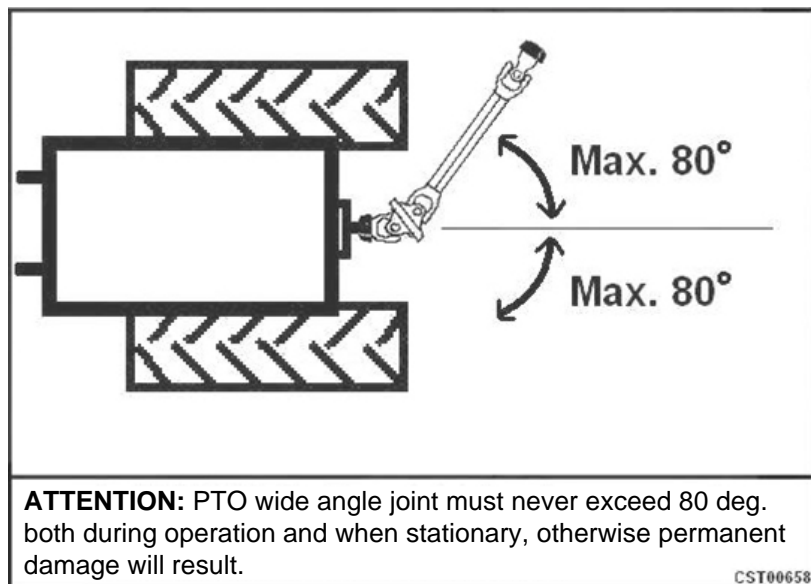

All PTO shaft grease points are to be serviced at 60 hour intervals.

The recommended quantities of grease in grams for each grease point are shown.

McHale Fusion Vario Baler & Wrapper

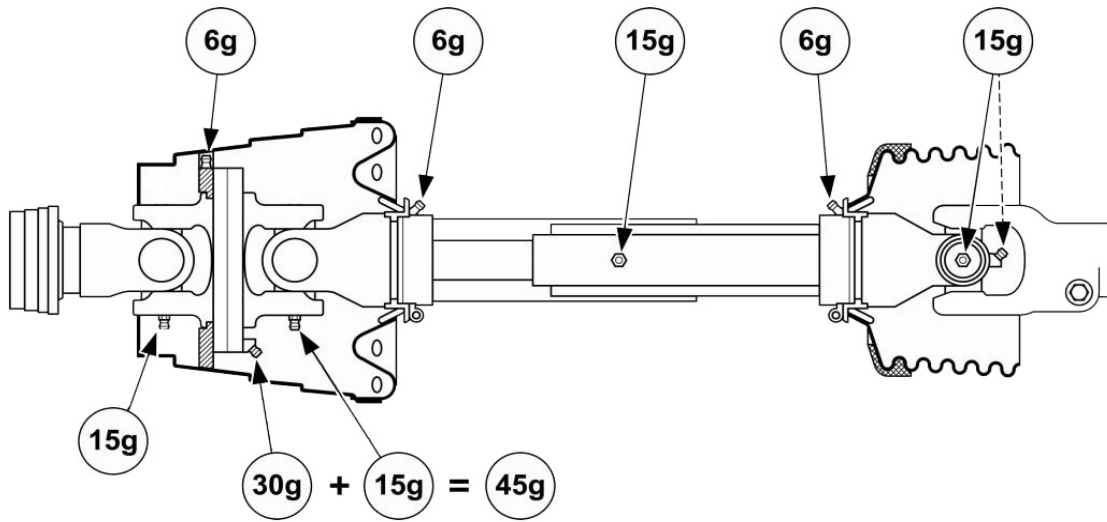

7

Electronic control system

(Software Version 68+)



Manual Screen 1 (The buttons/displays that vary on Manual Screen 2 are also shown)



Auto Screen 1 (The buttons/displays that vary on Auto Screen 2 are also shown)

7.1 Control box functions

No.	Manual		Automatic	
	Screen 1	Screen 2	Screen 1	Screen 2
L1	Select Automatic Mode		Select Manual Mode	
L2	Display Menu			
L3	Net feed	Film Clamp Open	No function	
L4	Net cut	Film clamp release	No function	
L5	Density release/wrapper rotate reverse		No function	
L6	Toggle between Man Screen 1 & 2		Toggle between Auto Screen 1 & 2	
R1	Open chamber door	Raise floor	Number of chopping knives	
R2	Close chamber door	Lower floor	Unblock/floor reset	
R3	Transfer cradle up	Lower knives	Pause/Net feed	
R4	Transfer cradle down	Raise 15 knives / 7 knives *	Pause Transfer/Transfer bale	
R5	Tip arm up	No function / Raise 8 knives *	Resume/Re-wrap	
R6	Tip arm down	Wrapper forward rotate	Tip bale	
7	Home screen (Returns from the Menu to the previous screen)			
8	Camera Toggle Button (Switches between the main screen & camera image)			
9	ESC (No function)			
10	Enter (No function)			
11	STOP Button (Disables all machine functions)			

Alternatively use the touchscreen to select the appropriate button.

* Second option applies when Selectable Knives are operational.

Please see the pull-out guide for this Electronic Control System at the end of this chapter. This can be removed and laminated to keep in your tractor and familiarise yourself with the functions of the controller.

7.2 Control box features

7.2.1 Working display

When the control box is first switched on it displays “Loading”.

After a short delay, the working display appears. The working display features an image of the machine, which is surrounded by general working information.

7.2.2 Manual/Automatic modes

There are two working screen modes:

1. Manual - Shows solid external machine image
2. Automatic - Shows transparent view, displaying internal components

There are two screen options for the Manual mode and two screen options for the Automatic mode. The reason for this is to show extra information displays.

To switch between the Manual and Automatic modes, press “Auto/Man” (Button L1). The selected control mode is displayed in the top left corner of the screen. The “AUTO” text is shown in yellow to differentiate it, along with a transparent view of the machine.

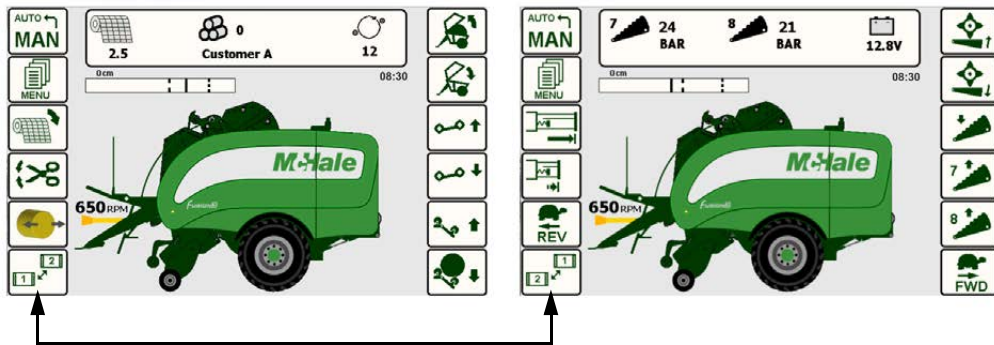

Figure 7.a - Manual Screen Display (Screen 1 on LHS & Screen 2 on RHS)

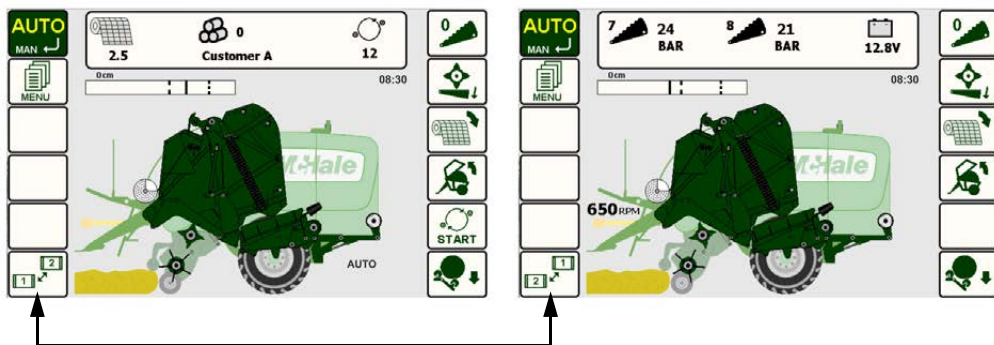

Figure 7.b - Automatic Screen Display (Screen 1 on LHS & Screen 2 on RHS)

McHale Fusion Vario Baler & Wrapper

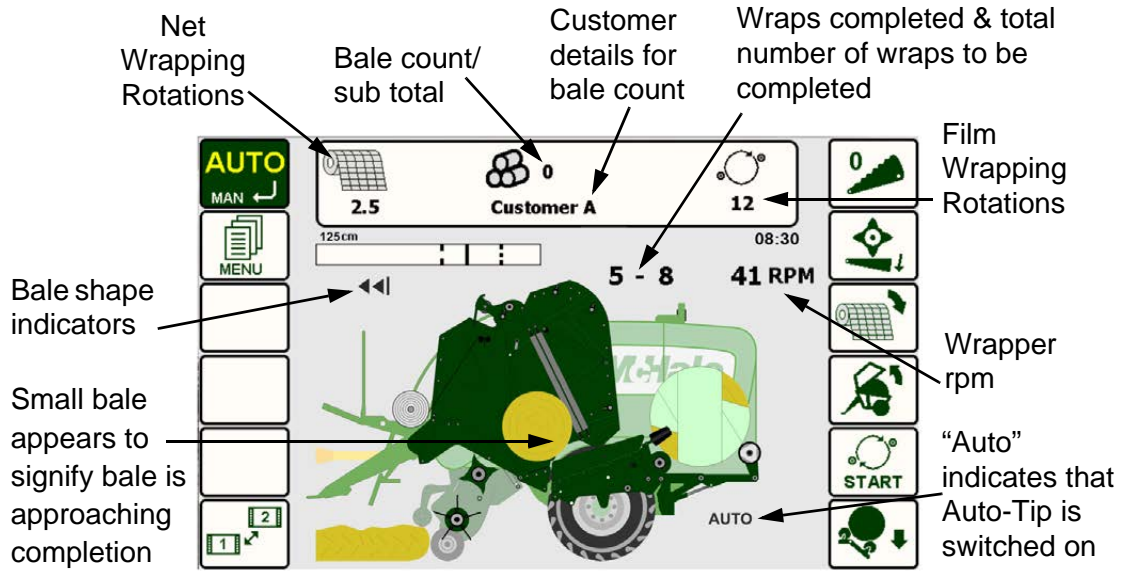

Figure 7.c - Icons on Screen 1 (Automatic)

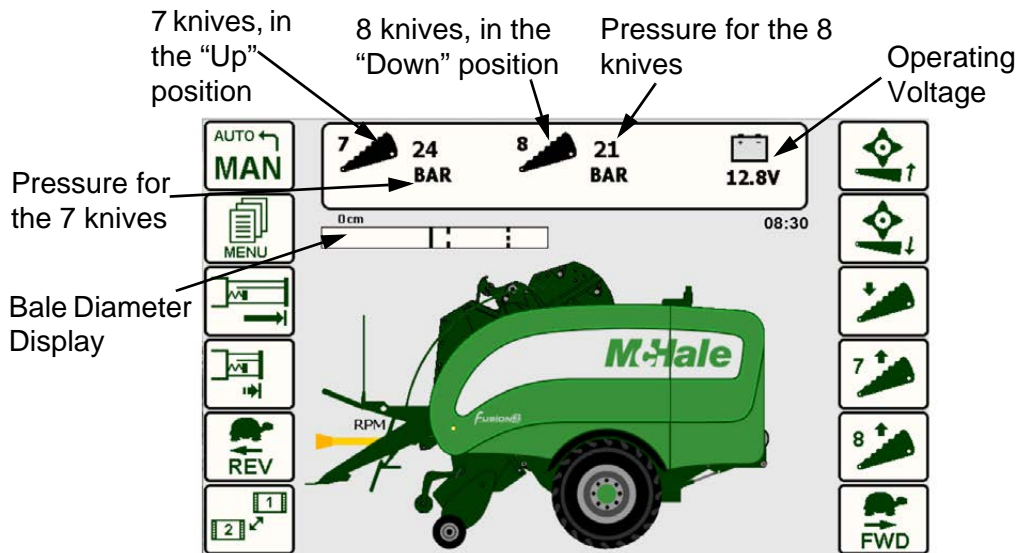

Figure 7.d - Icons on Screen 2 (Manual)

7.2.3 Film wrapping

The selected number of rotations is displayed on the right side of the top centre panel of Screen 1 (Man/Auto). The number of rotations is adjustable in the Menu options (See "Machine setup" on page 65). When wrapping is switched to "On" in the Menu, this icon will be displayed, showing the preset number of rotations. If wrapping is switched to "Off", this icon will not be visible. On the main section of the screen, above the image of the Fusion, the number of completed wraps and the target number of wraps is displayed, when the wrapper is rotating. (See Figure 7.c.)

7.2.4 Net indicator

The net indicator rotates when net is being applied. This stops rotating when the net knife trips to cut the net. (See Figure 7.c)

7.2.5 Bale counters

The bale count sub total is displayed in the middle of the top centre panel of Screen 1. The control box contains ten different bale counters (A-J) which can be reset and a grand total counter which can not be reset. (See “Bale Count” on page 67) The current bale counter is set in the Menu.

7.2.6 Voltage monitor

The control box monitors its operating voltage and displays it on the right side of the top centre panel of Screen 2. If the voltage falls below 11 volts the “Low Voltage” warning message is flashed on the display.

7.2.7 Wrapper ring rotation speed (rpm)

The wrapper ring rotation speed, in revolutions per minute, is displayed over the wrapper of the machine image on the screen. (See Figure 7.c)

7.2.8 Manual wrapping

Buttons L5 and R6 on Screen 2 (Manual Mode) are used to manually rotate the wrapper ring. Pressing and holding forward (Button R6) or reverse (Button L5) once will rotate the ring slowly. Pressing forward (Button R6) twice and holding it will rotate the ring forward at full speed.

7.2.9 Bale diameter display

A bar graph shows the live bale diameter.

- The first dashed line shows the minimum bale size that can be wrapped (110 cm).
- The second dashed line shows the maximum bale size that can be wrapped (145 cm).
- The bar graph is green when between these lines, i.e. wrapping is allowed.
- The bar graph turns red outside these lines, i.e. wrapping is disabled (0 - 110 cm and 145 - 168 cm).
- The actual bale size is displayed above the graph at the start of netting.

7.2.10 Knives operation

Standard Knife Operation allows all 15 (or 25) knives to be raised/lowered together.

If **Manual Mode** is selected there are two buttons for controlling the knives on Screen 2.

1. Button R3 lowers all of the knives
2. Button R4 raises all of the knives

McHale Fusion Vario Baler & Wrapper

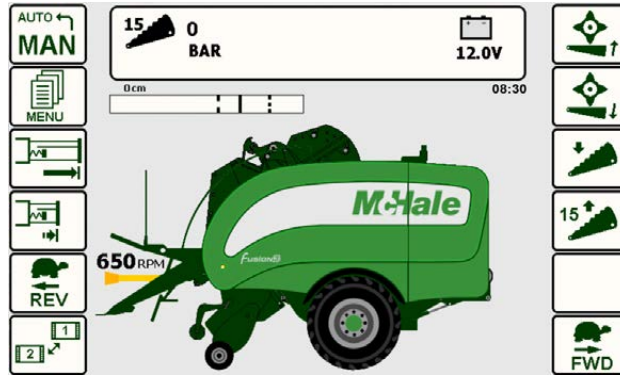

Figure 7.e - Standard Knife Operation (Manual, Screen 2)

The knife pressure in Bar is displayed in the top centre panel of Screen 2. When the knives are raised the pressure will increase and stop at the normal working pressure, approx. 50 bar.

Sometimes, if the knives have not been used for a while, full hydraulic pressure may need to be used. To do this, the “knives up button” (R4, Screen 2) should be pressed and when normal working pressure is reached, it should be released and then pressed again.

The pressure will then increase to the maximum allowed and a “Knife pressure too high” warning will be displayed to warn the operator not to bale with the pressure this high. To release the pressure, lower the knives fully by pressing “knives down” (Button R3, Screen 2).

In **Automatic Mode**, Button R1 is toggled to select the number of knives desired, 0 or 15. The machine will automatically move the knives to the correct position and constantly monitor the knife pressure and correct it, as necessary

A sensor indicates when the knives are fully up. The knife symbol will be shown as follows (See Figure 7.f):

- Completely black when the knives are up
- Only an outline of the knife will be shown if they are down

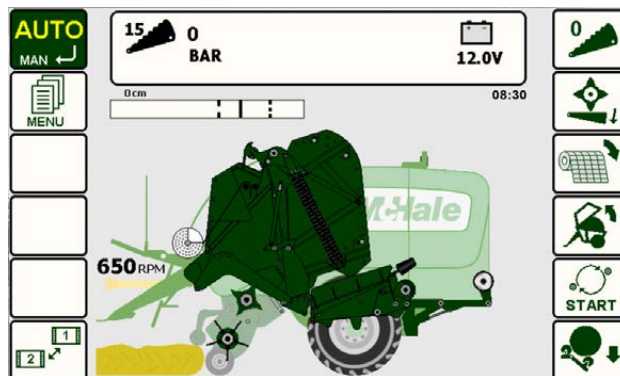

Figure 7.f - Standard Knife Operation (Automatic)

McHale Fusion Vario Baler & Wrapper

Selectable Knives Operation is an optional extra with the **Fusion Vario** which allows the selection of 0, 7, 8 or 15 knives (0, 12, 13 or 25 with 25 knife option) from the control unit.

In **Manual Mode**, on Screen 2, there are 2 buttons used to raise the knives, one for 7 knives (Button R4) and one for 8 knives (Button R5). Pressing “knives down” (Button R3) lowers both sets (7 & 8) together. There are two knife pressure displays, one for the set of 7 knives and one for the set of 8. (See Figure 7.d)

In **Automatic mode**, 0, 7, 8, or 15 knives can be selected. This is done by toggling the knives button (Button R1) to the desired knife setting.

A sensor indicates when the knives are fully up. The knife symbol, for 7 & 8 knives will be shown as follows (See Figure 7.g):

- Completely black when the knives are up
- Only an outline of the knife will be shown if they are down

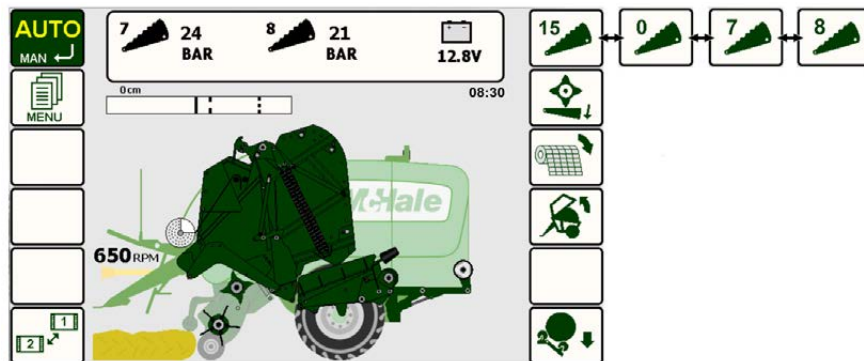

Figure 7.g - Selectable Knife Operation (Automatic)

7.3 Automatic operation

Automatic operation is the preferred method of operation on a day-to-day basis, allowing the machine to free-flow through each cycle. Manual operation is generally used when the user wants to have direct control over individual functions for service/maintenance reasons.

When the control box is switched on, Automatic mode can be selected by pressing Button L1. AUTO will be displayed in the top left of the screen, in yellow font and **Fusion Vario** image will change from solid to transparent.

Netting: A single beep sounds as bale approaches completion. The “Net Feed” (Button R3) may be pressed at this point to delay the net from feeding, if the operator wants to pack a little extra crop into the chamber. As crop continues to build up in the chamber, a series of beeps will sound for 3 seconds when the bale has reached the predetermined density (bale full) to alert the operator that netting is about to start. The operator must stop the forward movement of the tractor at once. Next, a continuous beep informs the operator that the netting has started and the wrapped bale on the wrapper will be tipped off automatically, if “Auto tip” is turned on. If the net fails to feed or runs out a “Net error” warning will be displayed. The roll of net can be replaced and “Net Feed” (Button R3) is pressed to start netting again.

McHale Fusion Vario Baler & Wrapper

Transfer: After the set number of net layers are applied to the bale, the net is cut and the chamber opens, ejecting the bale to the wrapper cradle. The drop floor is automatically topped up after the chamber door is closed to ensure it is in the correct position for optimum chopping performance.

Transfer pause feature: This feature allows the operator to pause the bale from being transferred from the chamber to the wrapper. This can be useful in hilly conditions. The 'Transfer' button should be pressed at any time during netting to activate the pause. A yellow box will be shown around the button symbol to show the pause is active. Once netting has finished and the operator wishes to start the transfer, press the 'Transfer' button again.

Wrapping: Once the chamber has closed, wrapping will start if the wrapper is on. Otherwise a beep will sound to indicate that the unwrapped bale is ready to be tipped. The film sensors will monitor the film usage throughout wrapping. If one roll of film runs out, a warning will be displayed and the machine will automatically continue to wrap the bale with the one remaining roll. A short beep will indicate that wrapping has completed.

Wrapper rotations: Film layers are set by the number of ring rotations. Count the number of rotations required to cover the bale once and add 0.5 of a rotation, then multiply this resultant figure by half the number of layers required, e.g. $(3.5 + 0.5) \times 2 = 8$ rotations for four layers. (See "Machine setup" on page 65)

Tipping: Once the bale is finished wrapping, it can be tipped off at any time, by pressing Button R6. If "Auto tip" is turned on, then the bale will be automatically tipped when netting starts on the next bale. If 'Auto tip' is turned off then the bale must be manually tipped by one press of Button R6 every cycle. "Auto" will be shown on the screen to indicate when Auto Tip is switched on.

Unblocking: If a blockage ever occurs in the feed channel during baling, the operator will be alerted by the sound of the PTO slip clutch. The PTO should be disengaged immediately and "Unblock" (Button R2) pressed for 1 second to activate the unblock routine and drop the floor and knives. Once the floor has been lowered, the PTO can be smoothly re-engaged to feed the blockage through to the chamber. Pressing "Reset" (Button R2) once will reset the floor and knives and baling can continue.

7.4 Menu structure

Press “Menu” (Button L2) to display the Machine Menu.

The Machine Menu is displayed as a series of 6 tabs, with the first tab selected i.e. Machine Setup. The first item in the tab will be selected. When a menu item is selected its border colour will change from black to yellow, see below.

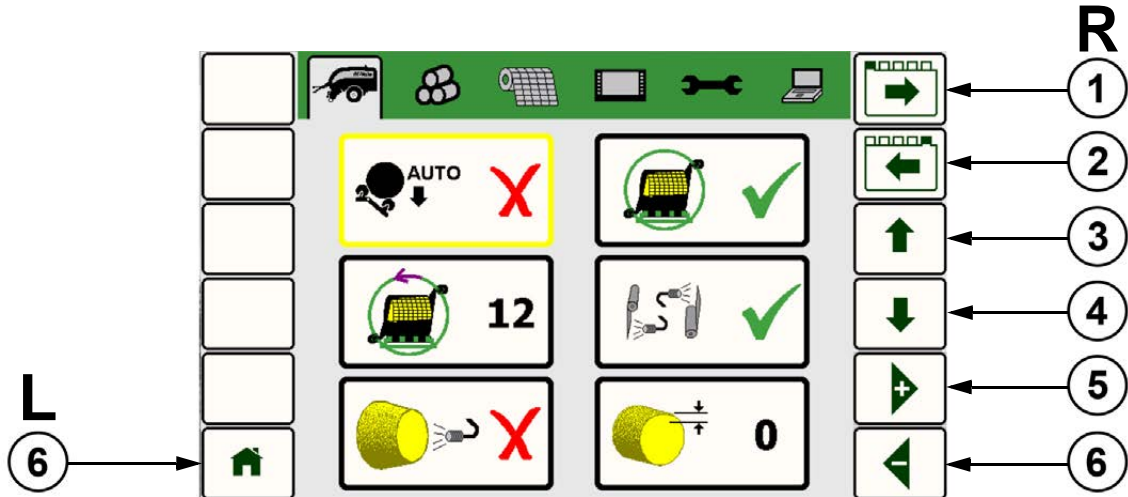

Use the following buttons to navigate the Menu Structure:

R1	Move a tab to the right
R2	Move a tab to the left
R3	Move up an item in the selected tab/screen
R4	Move down an item in the selected tab/screen
R5	Increase the value of a selected numeric item by 1 / Move through the options available to select the desired setting
R6	Decrease the value of a selected numeric item by 1 / Move through the options available to select the desired setting
L6	Return to the Home Page i.e. returns to the previous screen before the Menu (Button L2) was selected. This performs the same function as pressing the Home (Button L6) along the bottom of the controller.

Alternatively use the touchscreen to select the appropriate tab and/or menu item.

7.4.1 Machine setup

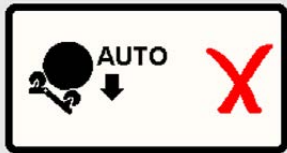
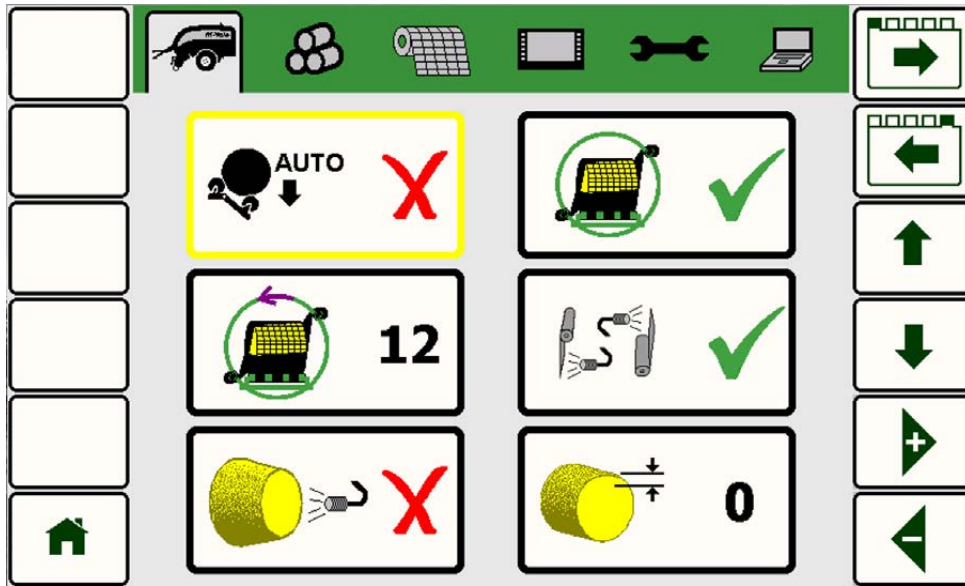

Auto Tip - This setting can be set to On/Off (✓/✗). When set to “On” the bale tips automatically during netting of the next bale in the chamber.



Wrapper - This setting can be set to On/Off (✓/✗).

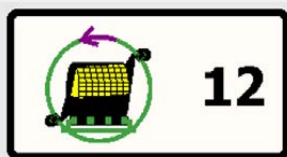

Wrapper Rotations - This setting determines the number of film wrapping rotations. It is adjustable from 2 to 99.

McHale Fusion Vario Baler & Wrapper

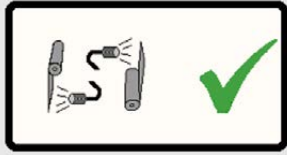

Film Sensor - This setting can be set to On/Off (✓/✗). Normally set to “On”, it can be set to “Off” if there is a fault with the film sensor system. The film sensor monitors the passage of film through the dispenser rollers. If one dispenser stops feeding film due to a roll coming to an end, the control box will give an audible alarm and flash the “1 Dispenser Only” symbol. Bale rotation goes into 50/50 mode, rotating the bale at half speed and the remaining wrapper revolutions will be doubled, so the correct film coverage will be applied for the remainder of the bale. If the second dispenser empties, the dispensers will rotate slowly and stop at the loading position. The control box will display the “Out of Film” symbol and wait.

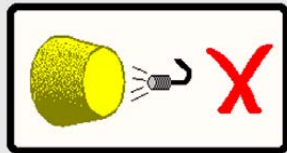

Bale Shape Sensor - This can be set to On/Off (✓/✗). When set to On, arrows appear on the screen to show the operator which way to steer the tractor. The more arrows that appear, the more mis-shaped the bale.

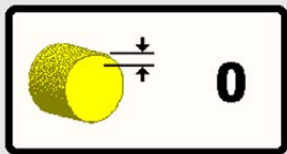

Diameter Correction - This is used to nudge the bale size +/- 5 cm if the actual bale size does not match the diameter setting.

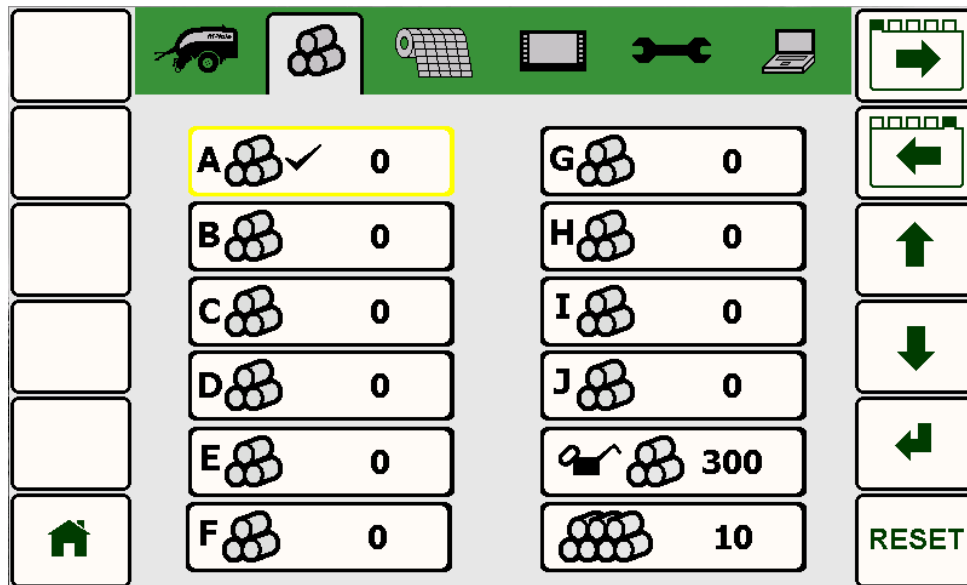

7.4.2 Bale Count

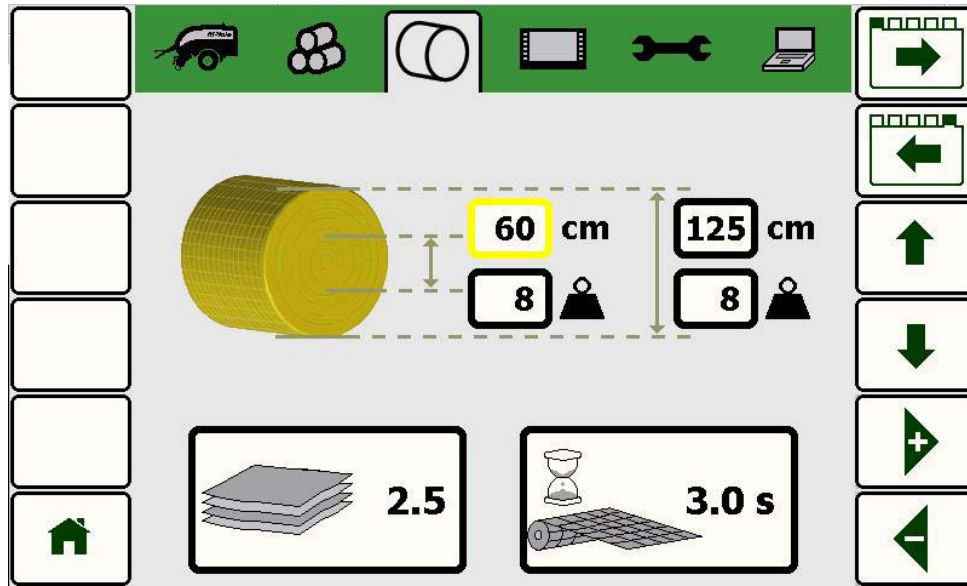

- **Bale Count** - There are ten bale sub totals to choose from (A-J). When a bale total is selected it will have a black arrow to the left of it, see A above. Select the appropriate parameter and then use the up & down arrow keys (R3 & R4) to change the sub total. You can enter/change the customer details for each bale count by pressing “Enter” (R5). A new screen will appear with a keypad which can be used to enter the details.
- The lube count is after bale sub total J and has an oil can symbol.
- All subtotals and the lube count can be reset by pressing ‘Reset’ (Button R6). The grand total cannot be reset.

7.4.3 Net settings

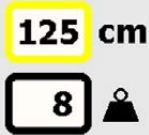

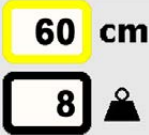
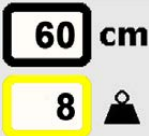
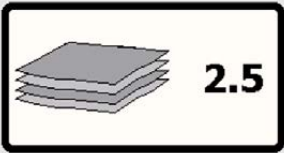
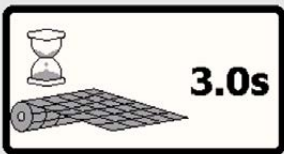
	<p>Bale Diameter - This can be set from 60 - 168 cm. (Wrapping is automatically disabled if the diameter is below 100 cm)</p>
	<p>Bale Density - The bale density can be set from 1 to 10.</p>
	<p>Core Diameter - Sets the bale core size.</p>
	<p>Core Density - Sets the bale core density.</p>
	<p>Net Layers - This setting determines the amount of net layers to be applied to each bale. It ranges from 1.1 to 9.9.</p>
	<p>Net delay - This setting sets the delay from the 'bale full' beeper to the point when net feeds into the chamber. It ranges from 0 - 9.9s.</p>

7.4.4 Display settings

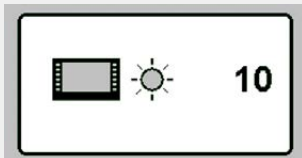
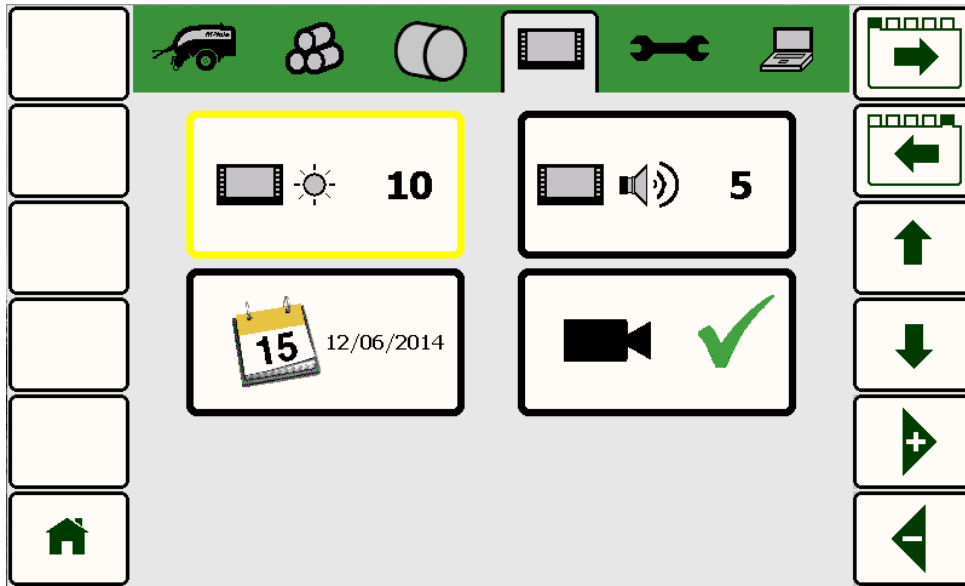

Backlight - This sets the brightness of the screen from 1 to 10.

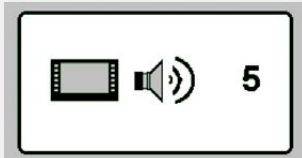

Volume - The volume of the controller can be adjusted from 1 to 5.



Auto Camera Mode - This can be set to On/Off/Manual (✓/✗/☞). When set to “On” it automatically switches to the camera image during netting/bale transfer/tipping and then automatically returns back to the main screen once wrapping has started. It also switches to the camera image during manual operation of the main machine functions. When set to “Manual”, pressing button 8 will manually toggle between the camera image and the main screen. When set to “Off”, the camera image cannot be activated.



Clock/Date Adjust - Select the Clock/Date Adjust menu item.

7.4.5 Technician menu

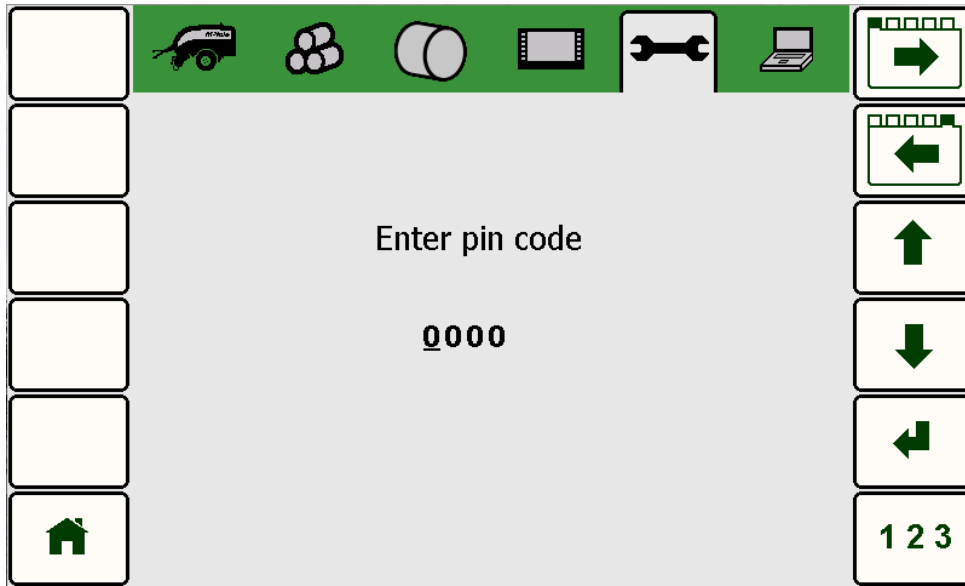

The technician menu has a lot of critical settings and is reserved for **McHale** engineers only. A pin code needs to be entered to access the menu. The same applies to the final “diagnostics” tab.

7.5 Warning messages

Front Stop Switch



When the front stop button is pressed it disables all functions and displays the “Front Stop Switch” warning. Turn clockwise, to the reset position, to resume normal operation.
(2016)

Rear Stop Switch



When the rear stop button is pressed it disables all functions and displays the “Rear Stop Switch” warning. Turn clockwise, to the reset position, to resume normal operation.
(2028)

Rear Panel Switch



A mechanical safety switch on the left rear door (where dispenser film is loaded), disables all functions when the door is open. If the rear door is not correctly fastened, the “Rear Panel Switch” warning is displayed.
(2029)

Wrapper too fast



This warning message will be displayed if the wrapper speed goes above 40 rpm. Speed is factory set at 36 rpm from the factory so this warning will not usually be seen unless the hydraulic settings have been tampered with. Contact your **McHale** dealer if you see this.
(2013)

Motor speed sensor



This warning will be shown if pulses are not seen from the motor speed sensor, once the wrapper ring starts to rotate. Contact your **McHale** dealer if you see this.
(2008)

1 dispenser film only



When the film sensor is switched on, failure of one dispenser to feed film will flash this warning on the display and the wrapping rollers will operate in 50/50 mode giving a correct wrap with the remaining film roll. Press “ESC” (Button R6) to silence the alarm.
(2024)

Out of film

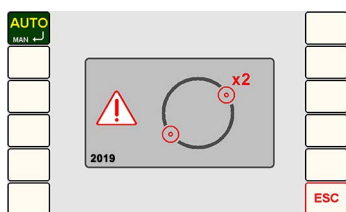

When both film rolls are empty, this warning is shown on the display and the dispenser rotates slowly to the loading position where the first roll is replaced. (See section “Loading plastic film” on page 77) Press “ESC” (Button R6) to silence the alarm.
(2019)

Unblock

This is not really an error message but it signifies that unblock is active. A quick push on “Reset unblock” (Button R2) on the control box will restore everything to a working condition.
(2001) & (2002)

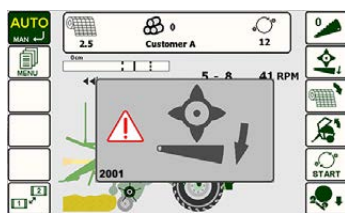

Unblock

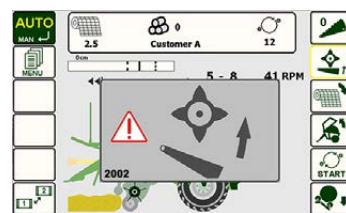

Reset unblock

Lube count



An alarm is provided to remind the operator to grease the machine and top up the lubrication oil. This counts down from 300 and gives a reminder at zero. Press “Reset” (Button R6) to clear the warning. It may be reset sooner, if desired, from within the bale count menu. (See Section “Bale Count” on page 67)
(2018)

Knife pressure too high



This tells the operator that the hydraulic pressure holding up the chopping knives is too high for baling which could lead to knife or machine damage. This warning will be seen if manually raising the knives with max pressure (See Section “Knives operation” on page 60). Switch back to Manual Mode and lower the knives to get rid of this warning.
(2003)

Low voltage



If the voltage drops below 10 volts, then this warning will be displayed. The usual causes are nearly always either an inadequate power lead cable or corroded connections. Ensure the cable connection to the euro socket is of good quality. Check the tractor power supply.
(2012)

Stop switch status



This indicates that “Stop” (Button 11) has been activated on the control unit. This disables all machine functions. Twist the “Stop” Button clockwise to reset.
(2014)

Net cut position

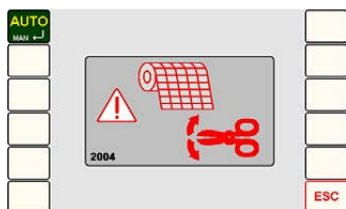

If the net is in the wrong position, this warning message will be displayed. The net needs to be reset manually. (See Section “Loading & operating the netter system” on page 39) Then press “Net Feed” (Button R3) to resume.
(2004)

Net error

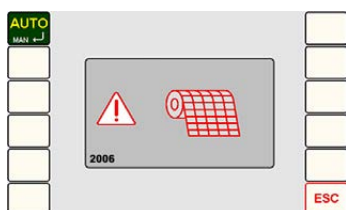

If the roll of net has run out or is torn this message will be displayed. The net needs to be reset/reloaded manually. (See Section “Loading & operating the netter system” on page 39) Then press “Net Feed” (Button R3) to resume.
(2006)

McHale Fusion Vario Baler & Wrapper

No net cut

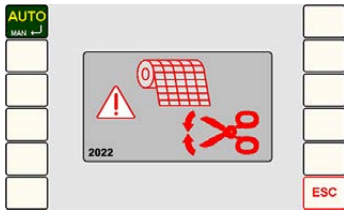

If the net doesn't cut or the machine hasn't detected it was cut, this message is displayed.

Contact your **McHale** dealer if you see this.
(2022)

Dispenser position error

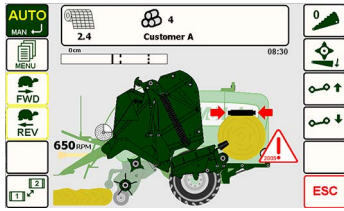

This message is displayed when the dispenser is in the wrong position for tipping the bale. Use buttons R3 & R4 (Screen 1) to rotate the wrapper to rotate it back to its home position.

(2005)

Tip arm position

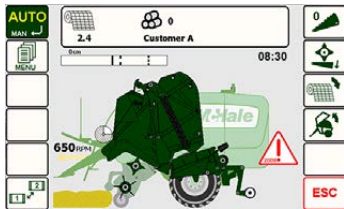

The tip arm is in the wrong position. This is shown if the arm is down when "AUTO" is selected.

Switch back to Manual Mode. Manually raise the tipping arm by pressing "Tip Arm Up" (Button R5, Screen 1).

(2009)

Tip bale

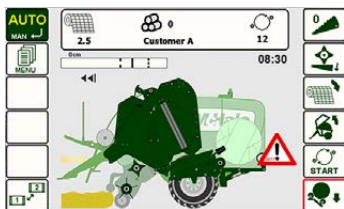

This message shows the bale on the wrapper flashing and prompts the operator to tip off the previous bale on the wrapping table, which is preventing transfer of the netted bale. If "Auto tip" is selected, the wrapped bale is automatically tipped. "Tip Bale" (Button R6), is pushed to complete the tipping cycle.

(2017)

No wrapper rotation



This indicates that wrapping has started but the wrapper ring is still not turning.

Check that the tractor oil supply is connected and turned on. Contact your **McHale** dealer, if the problem is not resolved.

(2007)

PTO overspeed



This warning appears if the PTO speed exceeds 700 rpm. Reduce the PTO speed.

(2023)

Wrap not complete

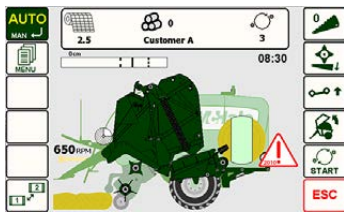

If “Stop” (Button 11) is pushed during wrapping of a bale, this error is displayed when the control box is next switched to “Auto”. To correct the error push “Resume/Re-wrap” (Button R5) to complete the wrapping cycle. Pushing “ESC” (Button R6) on the control box will cancel the error warning. (2010)

No CANBUS warning

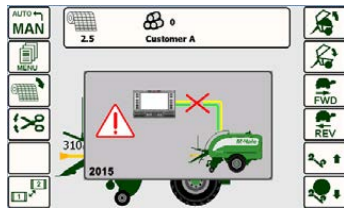

This message indicates that there is no communication between the control unit and the machine ECU. Contact your **McHale** dealer if you see this. (2015)

Bale Detect Sensor

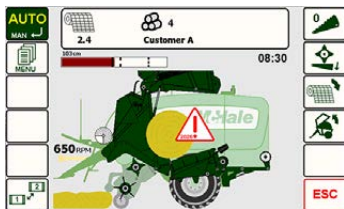

This message is shown if the bale is not detected in the transfer cradle during transfer. (2026)

Index warning



This screen is shown when dispensers are being indexed, using the external index button at the rear of the machine. See “Dispenser Park Button” on page 78. (2020)

Chamber not closed

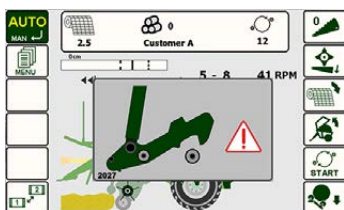

This message is shown if the chamber locks don't close fully after transfer, or if the chamber locks are open when Auto mode is activated. (2027)

Bale Detect Sensor Fault

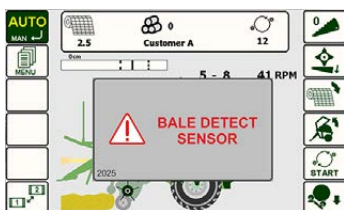

This warning will be shown if the bale detect sensor is already closed before the chamber begins to open to transfer the netted bale. Shut down tractor, remove key, apply brakes & tailgate safety lock (See 10.9) before entering machine. Then, check that there is no loose grass sitting on the bale detect sensor paddle. If loose grass is not the cause of the warning then contact your **McHale** dealer. (2025)

FUSION VARIO AUTO MODE GUIDE

Shows vital machine info. Press the screen toggle button to see more info.

- Net Layers
- Customer Name / Bale Count
- Wrapper rotations (not shown if wrapper is off)
- Knife position + pressure
- Power supply voltage
- Bale Diameter setting

Actual bale diameter shown when netting starts.

Switches between **Manual and Automatic** operation mode.

Menu Button
Access to menu settings.

Bale diameter graph shows live bale diameter progress. It turns green when bale is within allowable diameter range for wrapping.

Bale shape indicator arrows show direction to steer for optimum bale shape.

On/Off Button
Press and hold to switch on or off.

Auto Cut
Press + Hold for 1 sec to start. This rotates the wrapper one turn and cuts the film.

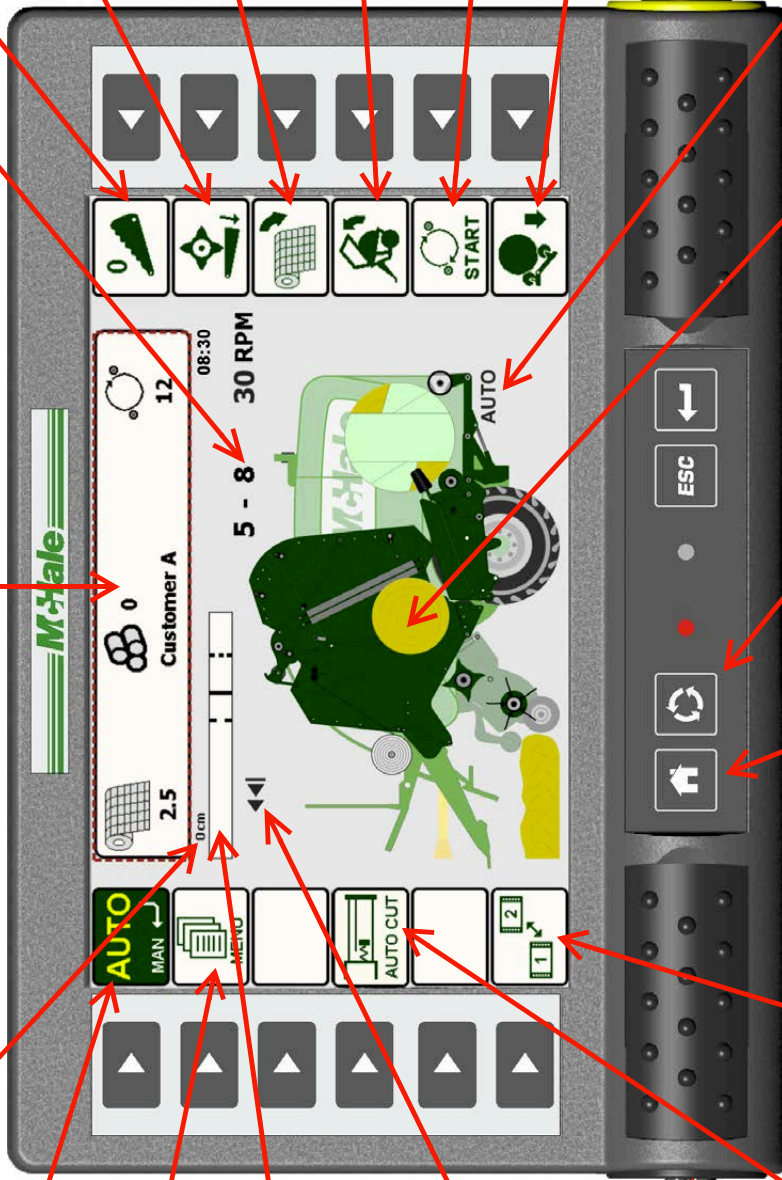

Shows the current and target wrapper revolutions.

Knives
Number of chopping knives engaged. Press to toggle available options.

Unblock
Press + hold for 1 second to start auto drop floor down sequence. Press again to reset the drop floor to the work position.

Net Feed/Delay
Press once to pause netting. A yellow box will highlight the button. Press + hold for 1 second to start netting.

Transfer
Press during netting to pause transfer. A yellow box will highlight the button. Press + hold for 1 sec to start transfer.

Wrapper
Press + hold for 1 second to start/resume wrapping.

Bale Tipping
Press to tip bale.

Stop Button
Disables the machine.

Icon displayed when automatic tipping is switched on.

Small bale shown when diameter approaches the target.

Toggles between main screen and camera image.

Home Button
Takes user back to main screen.

Screen Toggle Button
Switches between Screen 1 and Screen 2 in Man mode. Toggles between information at top of screen in Auto.



FUSION VARIO MENU GUIDE

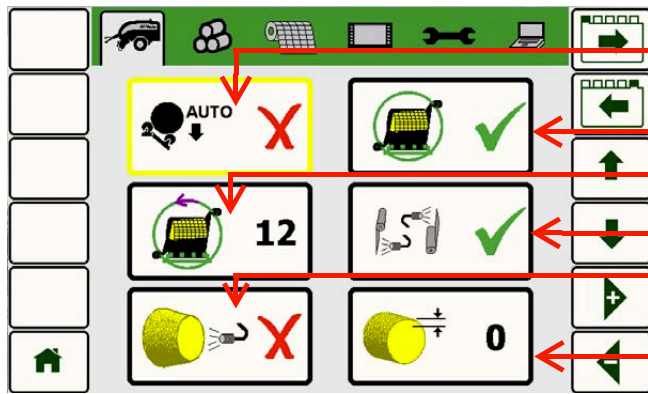

Baler setup

Auto-tip: When set to 'On' (✓), the bale tips automatically during netting of the next bale in the chamber. When set to 'Off' (✗), the Tip Button must always be pressed to tip the bale.

Wrapper: Used to turn the wrapper 'On' (✓) or 'Off' (✗).

Wrapper Rotations: This sets the number of wrapper rotations.

Wrapper Film Sensors: Turns the film sensors 'On' (✓) or 'Off' (✗).

Bale Shape Indicator: Turns the indicator 'On' (✓) or 'Off' (✗).

Diameter Correction: Used to nudge the actual bale size up or down slightly so that it accurately matches the diameter setting.

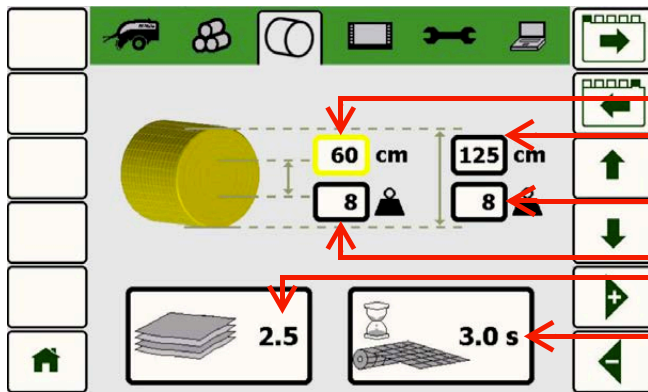

Net menu

Core Diameter: Sets the bale core size.

Bale Diameter: Sets the total bale size.

Bale Density: Sets the main bale density.

Core Density: Sets the bale core density.

Net Layers: Selects the number of layers.

Net Delay: Sets the delay between the bale full beeps and net starting to feed.

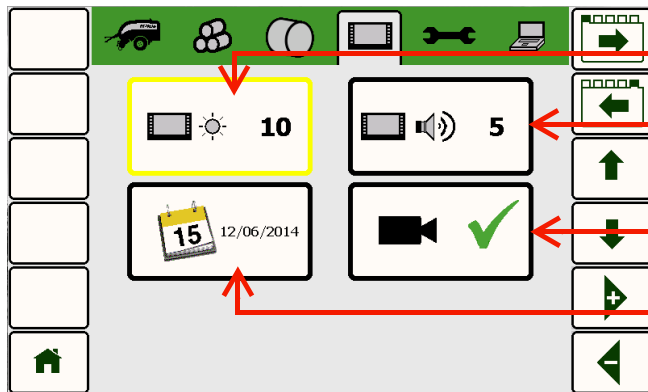

Control unit menu

Screen Brightness

Beeper Volume

Camera Mode: On (✓), Off (✗) or Manual (👉). When set to 'on', the camera image will automatically be activated during tipping, transfer and wrapping. When set to 'manual' the operator must toggle between normal screen and camera image.

Time and Date setup



8

Wrapper operation

The **McHale Fusion Vario** is designed with a wrapping system having two plastic film dispensers. Differing to conventional wrappers, the dispensers move vertically around the bale. The dispenser carrier system is mounted directly behind the baler chamber. Although the dispenser carrier ring is well protected by the safety guards and electrical safety switches, the operator must ensure that all people and animals are kept out of this region while operating the machine.



WARNING: Keep out of the “Danger Zone”

Keep all persons outside of the “Danger Zone” during all machine operations! See “Danger Zone” on page 17.



ENVIRONMENT: Recycling of the plastic film

Respect the environment! Never throw away or burn the waste plastic film. Always take waste materials to a recycling centre.

8.1 Loading plastic film

1. The dispenser safety door, on the left hand side of the machine (See Figure 8.a) can be opened by releasing the primary latch (A) with a 13 mm spanner or flat blade screwdriver and then pushing upwards on the secondary latch handle (B).
2. Remove the linch pin and release the dispenser film roll lock (See Figure 8.b)
3. Remove the old core and ensure it is disposed of responsibly.
4. Push the new roll on the central pin, engage the film roll lock and reinsert the linch pin.
5. Thread the film through the dispenser rollers, as per the threading diagram (See Figure 8.c), taking care not to trap fingers between the rollers.
6. Pull approximately 1.5 m of film away from the dispenser and make a knot at the end of the plastic film (See Figure 8.d)
7. Close the dispenser safety door
8. Push the rear mounted dispenser park button (C), for approx. two seconds, in order to rotate the next dispenser to the loading or “home” position (See Figure 8.e). The dispenser ring can only rotate when the safety door is closed and the control box must be in Automatic Mode when depressing this button.
9. Open safety door and load film, as before.
10. Pull approx. 1.5 m of film away from the dispenser and make a knot at the end, as before.

McHale Fusion Vario Baler & Wrapper

11. Slot the knotted end of the film in the left hand side slot of the rear wrapping roller as shown in Figure 8.f.
12. Grab hold of the dangling film on the right hand dispenser and slot the knotted end of the film in the right hand side slot of the rear wrapping roller, as shown in Figure 8.g.
13. Close the door firmly making sure that both primary and secondary latches have been engaged.



WARNING: Do not clamp film in the “cut & hold” mechanism

Do not attempt to clamp plastic film in the “cut & hold” mechanism as this action may result in serious injury!



NOTE: Resume a cycle interrupted by “Out of film” error symbol

Pushing the “Resume” on the control box will complete the wrapping cycle of a bale, that is interrupted by an “Out of film” error symbol shown in Figure 8.h.

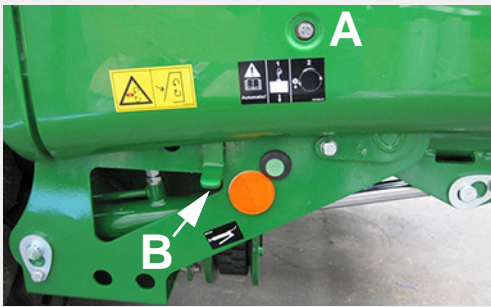

Figure 8.a - Door Latch

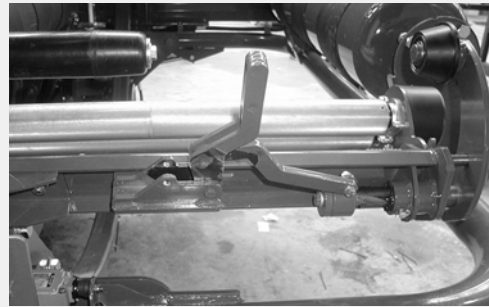

Figure 8.b - Film roll lock (open)



Figure 8.c - Film threading diagram



Figure 8.d - Film knot

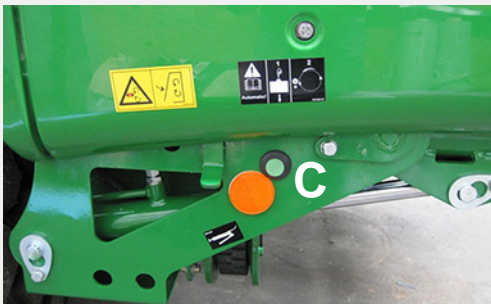

Figure 8.e - Dispenser Park Button

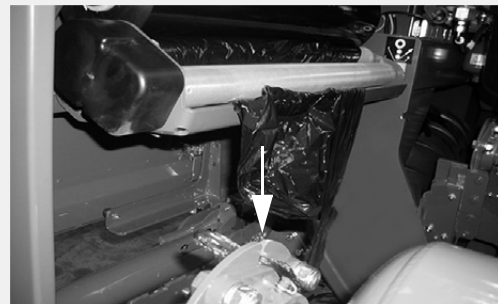

Figure 8.f - L.H.S. Film slot

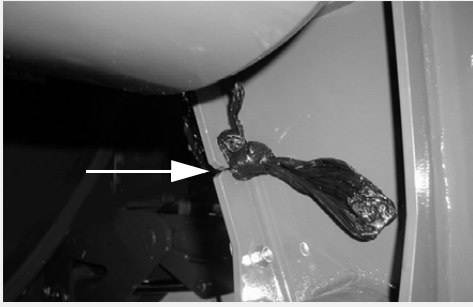

Figure 8.g - R.H.S Film slot

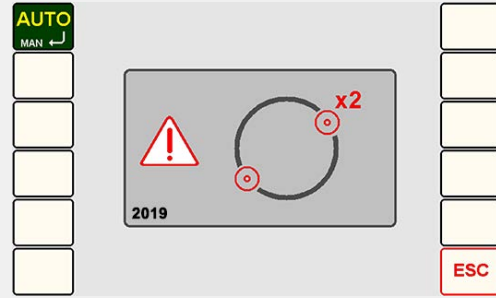

Figure 8.h - "Out of film"

8.2 Plastic film requirements

Good quality silage depends on the use of top quality plastic film, in addition to well shaped dense bales. Low standard film material will not produce good silage regardless of how well the machine wraps the bale. The plastic film should be used and stored according to the instructions of the film manufacturer.

It is recommended that a minimum of six (6) layers of film be applied to the bale. If the material being wrapped is of a hard or stemmy nature it may be necessary to apply eight (8) or ten (10) layers to ensure a good airtight package.



NOTE: Operator must check to ensure bales are wrapped correctly

The operator needs to ensure that the bale is wrapped correctly. It is good practice to check the bales regularly after being wrapped for torn, split or perforated plastic film.

8.2.1 Determining the number of wrapping ring rotations

Extra care, regarding the amount of wrapping ring rotations must be taken when wrapping bales with the **Fusion Vario**. This is because of the following reasons and these should always be taken into account when deciding the number of wrapping ring rotations to apply:

1. It is a variable diameter baler, and so each time the bale size is changed, the no. of wrapping ring rotations must also be changed.
2. Variable conditions of the forage material being baled will give variations to the bale size for wrapping. i.e. higher % DM in the forage will usually give slightly larger diameter bales when compared to low DM forage. The best way to resolve this is to apply extra net in the baler in order that the bale size is maintained.
3. Bales from the **Fusion Vario** are usually more dense, than bales of the same size from a typical fixed chamber eg. roller baler and because of this extra weight, a minimum of 6 layers of wrapping film must be applied. Where bales, regardless of size are likely to exceed 1,000 kg in weight, then 8 layers of wrapping film are recommended.
4. Also with this extra bale weight, consideration must be given, firstly, to the handling machinery and secondly, to the distance, the wrapped bales are to be transported. It is much more difficult to safely handle, without damaging the film, bales of 1,000 kg + compared to more typical 800 kg bales. Where either

McHale Fusion Vario Baler & Wrapper

of the above conditions are not ideal, then an extra 2 film layers must be applied, and then check at the bale stack for any signs of damage to the film on the bale.

5. It important to note that for high density bales, bale weight does not decrease when baling high %DM forage (eg. 50%DM) when compared to low %DM forage (eg. 25%DM). So it cannot be assumed that because the forage is higher %DM in one field compared to another, that it is safe to reduce the number of layers. Bale weights could still be + 1,000 kg, and so the extra layers of film will still be required.

To determine the number of wrapping ring rotations required to cover a bale, carry out the following procedure:

1. Using manual operation, from the control box, manually count the number of wrapping ring rotations to cover the bale completely with plastic film
2. Add 0.5 to this number
3. Multiply the resultant figure by 3 (for 6 film layers), 4 (for 8 film layers), 5 (for 10 layers), 6 (for 12 layers), etc
4. Round up to the next full number if the result contains a fraction of a full number

Example:

- Number of “Wrapping ring rotations” to cover bale: $3.5 = (x)$
- Number of rotations to apply 6 layers of film to bale = $(3.5 + 0.5) \times 3 = 12$

Important Notes:

- (x) “Wrapping ring rotation” = both dispensers rotating 360° around the bale.

8.3 Wrapping process

The wrapping process starts automatically as soon as the bale has been transferred from the bale chamber to the wrapping table (bale transfer cradle in the home position, chamber door closed, rear wrapping roller in the set wrapping position and the access panel door closed). After the bale is wrapped with the selected number of film layers, two (2) cut & hold units grip and cut the film. The wrapping cycle is completed and the bale is ready for discharging.

If “Auto tip” is selected, the wrapped bale is discharged when netting of the next bale starts.



NOTE: Bale will not transfer if dispenser ring is in wrong position

The bale will not transfer from the baler chamber if the dispenser ring is in the wrong position. This is a safety feature and is normal. In this case an audible alarm will sound and the “Dispenser position” error symbol will be displayed in the control box display. The forward and reverse soft key indicators will become active on the control box. Press the appropriate button in order to correct and once corrected the bale will transfer and the wrapping cycle will begin.

McHale Fusion Vario Baler & Wrapper

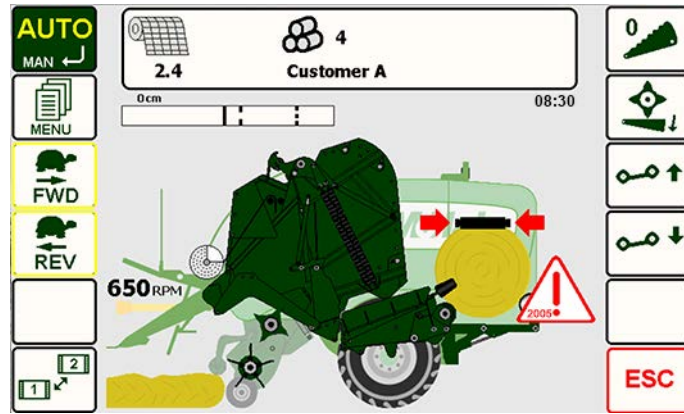

Figure 8.i - Dispenser position error symbol



CAUTION: Do not tip off bales while moving

The machine should not be moving when the bale is tipped off, as this greatly increases the risk of plastic film damage.

8.4 Dispenser adjustment

The dispenser rollers are set for a standard film stretch of 70%. Optional sets of dispenser gears for both 55% and 64% film stretching are available from your **McHale** dealer.

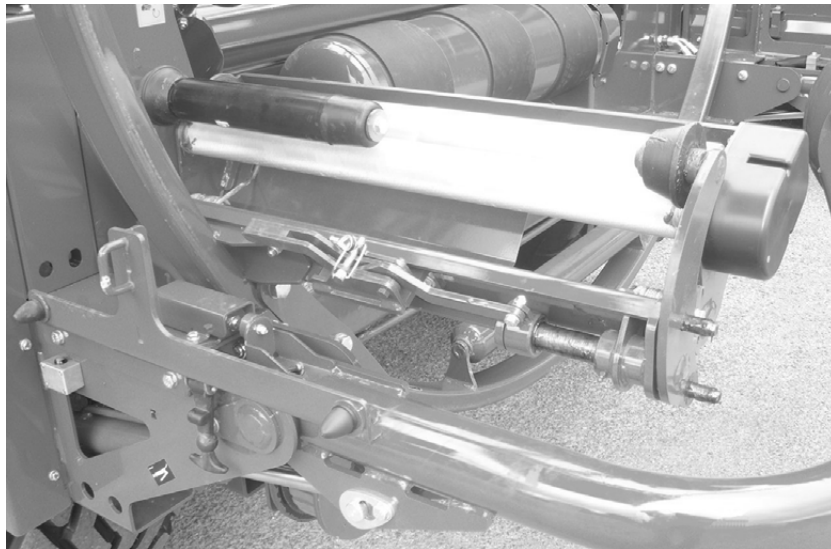

Figure 8.j - Dispenser in the “home” position

8.5 Cut and hold system



WARNING: Beware of knives & accumulators during maintenance

The cut and hold system utilises knives and accumulators in order to function. Beware of serious injury when carrying out any maintenance in this area. Turn off the tractor and remove the key from the ignition. Wear protective gloves and clothing, at all times! Also, never carry out any work on the hydraulic hosing because even when the machine is off, hosing remains under high pressure due to the accumulators.

The cut and hold system on the **McHale Fusion Vario** is designed to operate in conjunction with both the dispenser and table rollers to cut the plastic after a desired amount of film wrap has been applied to the bale, as set on the control box. See previous sections, for more information on the wrapping process. The cut and hold system operates by way of a slider (D) that slides in and out using a hydraulic ram. The slider (D) then clasps the film and retracts to hold the film between (C) and (D) which is then cut at knife point (B). Once the wrapping process resumes, the film is then released.



WARNING: Beware of knives & accumulators during maintenance

Before working on cut and hold rails, always release the hydraulic pressure from accumulators by wrapping the spanner and hose-fitting with a cloth, then slowly and carefully open the pressure hose fitting (See figure 8.k), allowing oil to release before re-tightening. Accumulator pressure will reset automatically following the first operation of the cut and hold cylinder in the fully out direction.

Never work on the cut & hold by holding out the rails against hydraulic pressure.



Figure 8.k - Release hydraulic pressure from accumulators

McHale Fusion Vario Baler & Wrapper

The cut and hold knife may be adjusted in and out by following the procedure below and by referring to Figure 8.l:

1. Remove the two M6 nyloc nuts and bolts that hold knife plate (A) using 10 mm spanners. Beware of the cutting knife!
2. Move the knife plate to the desired position. The factory setting is to the fully out position, as shown.
3. Insert the two M6 bolts and tighten nyloc nuts to 12 Nm.
4. Repeat for the other cut and hold.

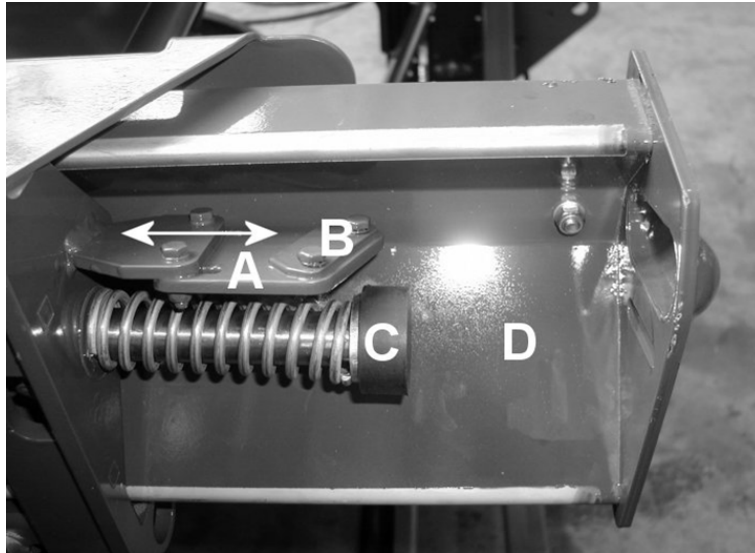

Figure 8.l - Cut and hold knife adjustment and removal

The cut and hold knife blade condition is very important for the proper operation of the cut and hold system. A blunt blade may not cut the film cleanly or possibly not at all. As such, the knives must be changed under part number CKN00011. Ensure all safety precautions are taken before carrying out the procedure on the following page.

Change the cut and hold knives by following the procedure and referring to Figure 8.l:

1. Loosen the two M6 setscrews that hold the knife clamp plate (B) in place using a 10 mm spanner or socket, beware of knife blade!
2. Remove used knife, noting that there is a spare knife blade held by the bottom of the knife clamp plate (B).
3. Place spare knife in the working position and place a new spare knife underneath, if available.
4. Tighten the two M6 setscrews to 12 Nm.

Cut and hold rail adjustment

After much use, the moving part of the cut and hold rail (C) may develop wear. In such a case this may be adjusted, to ensure optimum working of the cut and hold. While referring to Figure 8.m, adjust as follows:

McHale Fusion Vario Baler & Wrapper

1. Insert a 24 mm open ended spanner into slot (D) until it engages with the hexagon on adjuster cam (E).
2. Loosen M12 nyloc nut (B) on adjuster slightly, just enough to be able to turn adjuster (which works on a cam principle)
3. Turn adjuster (preferably clockwise from cam side E), with a 24 mm spanner, until the resistance to turning increases greatly.
4. Hold resistive pressure on the adjuster cam (E) and tighten the M12 nyloc nut.

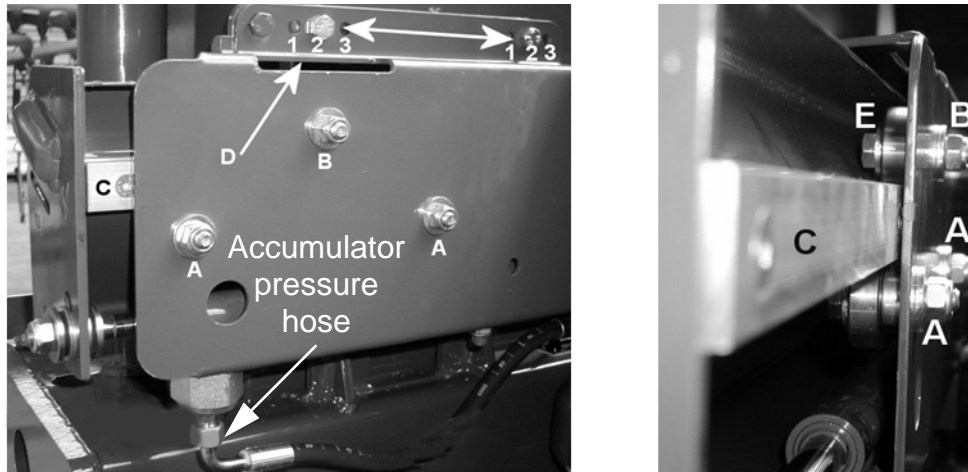

Figure 8.m - Cut and hold rail/horizontal position adjustment

Cut and hold horizontal position adjustment

The cut and hold assembly can be adjusted through three (3) different horizontal positions, if desired. The factory set position is position 2 as shown in Figure 8.m. Ensure that cut and hold assembly is safely secured (as assembly is quite heavy) before attempting the following procedure:

1. Loosen and remove the four M12 x 40 mm bolts and 12 mm spacers and carefully reposition bolts into the desired position i.e. 1, 2 or 3.
2. Place 12 mm spacers between cut and hold assembly and the main chassis, then tighten M12 nyloc nuts to a torque value, as described in Section "Tightening torque values" on page 117.

9

Road traffic safety & operation

9.1 Before travelling on any public roadway



WARNING: Complete a full inspection before travelling on the road

Ensure that a full inspection is completed every time before attempting to go on to a public roadway, always think and practice safety!

The following should be inspected every time, before travelling on a public road:

- Ensure that the tyres are set to the correct pressure as per safety decals and according to the specifications, as outlined in Section “Tyre specifications” on page 13.
- Ensure that all doors are securely closed and fastened, ensuring that primary and secondary catches are fully engaged, these should be kept clear of foreign objects to ensure proper and trouble free operation.
- The bale forming chamber should be emptied and there must be no bale on the wrapping table.
- The machine must be safely cleared of all loose forage. To carry this out, firstly turn off the tractor and fully isolate the machine by disconnecting all of the connections to the tractor unit.
- The PTO shaft must be fixed safely to the tractor PTO stub shaft.
- The lighting system of the machine must be connected to the tractor and must be in a fully functioning condition.
- The electronic control box must be switched off or disconnected from the power supply, see Section “Control box functions” on page 57).
- The hydraulic supply must be turned off and protected from accidental activation by disconnecting the hydraulic feed line. Support all loose lines in a safe manner.
- The pick-up guide wheels must be fixed in the road transport position (see Figure 9.a) and the drawbar/PTO stands secured in a working position, see section “Drawbar and PTO shaft stand usage” on page 51.
- Attention must be paid to the maximum travel speed-limit (40 km/h) printed on the chassis plate, on the left hand side of the machine. Other speed limits that may be printed, on the drawbar plate or axle plate, for example are not relevant.

McHale Fusion Vario Baler & Wrapper

- The brake system of the machine (hydraulic or pressurised air) must be connected to the tractor. Do not travel, with air brakes, until the required pressure is shown on the indicator of the tractor panel.
- Ensure that all the national road traffic regulations relating to the country are fulfilled i.e. the use of safety chains may be mandatory in certain countries.

9.2 Road transportation

- Close and secure all doors and panels.
- Empty the baling chamber and the wrapping table.
- Clear the machine of loose forage.
- Lift the pickup reel completely and close lever on hydraulic line (if fitted).
- Unlock the pick-up guide wheels and swing them backwards into the transport position, and lock them carefully.



Figure 9.a - Road transport position (pick-up guide wheels)

9.3 Road transportation with side tip attached



CAUTION: Side tip must not be used on public roadways!

Side tip must not be used on public roadways and must always be folded vertically beforehand.

- Side-tip must be folded vertically and secured, as shown in Figure 9.b.
- Ensure the transport-pin is secured in the transport position with the linch-pin attached.
- Do not attempt to go over 20 km/h at any time, while the side tip attachment is assembled to the machine.
- See Section “Side-tip” on page 109 for more details on the side tip attachment.

McHale Fusion Vario Baler & Wrapper



Figure 9.b - Road transport position (side-tip)

9.4 'Break-away' brake

The **McHale Fusion Vario** is fitted with a handbrake which must be applied when the machine is detached from the tractor. The handbrake handle has a rope fitted to a calibrated ring which must have the other end securely fixed to the tractor, each time the machine is attached to the tractor. If the machine hitch ever becomes detached from the tractor this rope will apply the brakes on the machine.



CAUTION: Ensure the hand brake is released when moving

Always ensure that the hand brake has been released before moving the **Fusion Vario** on the road or operating in a field.

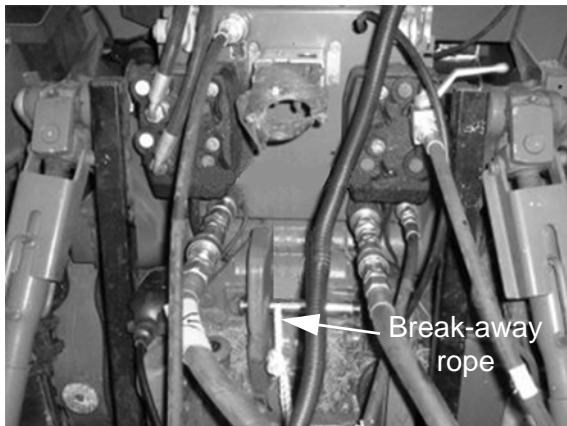

Figure 9.c - Break away rope fixed to tractor



Figure 9.d - Handbrake handle

10

Field operation & baler adjustments

10.1 Break-in period

McHale recommend a break-in period of approximately the first 50 bales or until the paint within the baler has lost its shine. During this break-in period, the sides of the bales may appear untidy, but once the side-walls have been polished smooth, then bale sides should look neater.

10.2 Swath preparation

An optimum baler performance of the **McHale Fusion Vario** requires a good swath preparation in advance. The optimum swath width is 1.5 m.



NOTE: Swath width is the most important factor in proper bale formation

A 1.5 m swath width provides optimum material flow into the bale chamber for even bale formation. A swath width greater or less than 1.5 m will lead to increased bale deformation.

In the case where narrower swaths are unavoidable, it is recommended that the swath be periodically directed 30-40 m to the right hand side and also the same distance to the left hand side of the pick-up as the baler is driven over the swath, see Figure 10.a.

Collect the material into one side of the pick-up for 6 to 8 seconds. Then cross over the windrow and collect material for the same duration. Reduce the length of time for heavy windrows and increase for lighter windrows.

Continuous weaving is not recommended as this will result in excessive material being placed towards the centre of the bale, see Figure 10.a.

In the case of wider swaths i.e. > 1.5 m; this size of windrow should be avoided, as in this case a greater amount of material will continue to be fed to the outside of the baler. As a result, a greater amount of material will be fed to the outer edges of the bale than to the centre, which will result in concave-shaped bales.

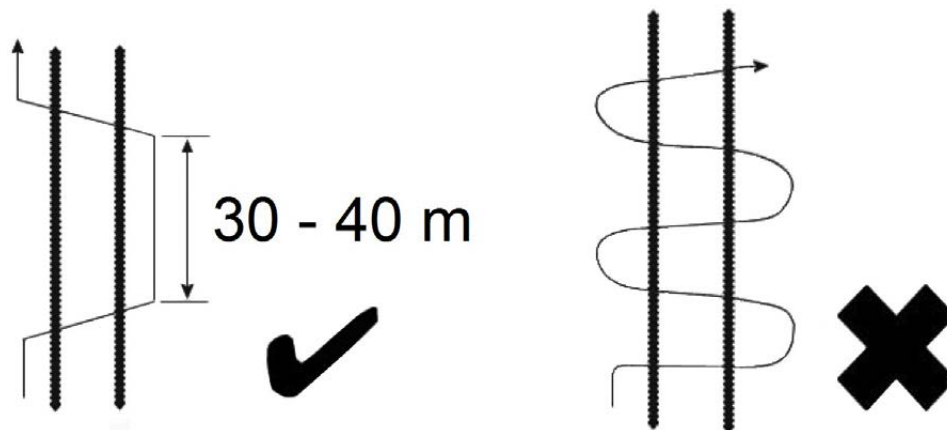

Figure 10.a - Swath widths - correct & incorrect

10.3 Pick-up reel height adjustment

Before working in the field unlock and swing the pickup guide wheels forwards and lock them again carefully. Use the appropriate hole in the adjusting bar so that the pickup is balanced and at the optimum working height with the pick-up tines being 2 cm above the ground.



NOTE: Wear and tear of pick-up tines

Working with the pick-up tines set too low will leave them susceptible to breakage and rapid wear!

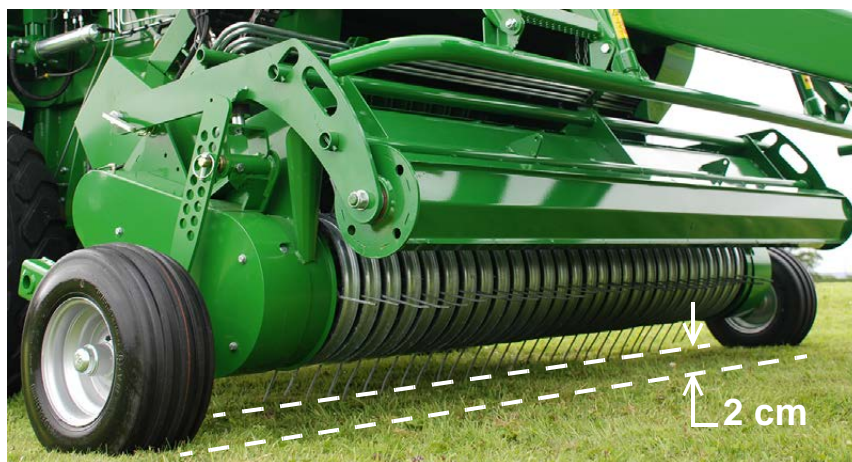

Figure 10.b - Pickup adjustment

10.4 Crop roller adjustment

The function of the crop roller and fingers is to hold down and spread out the baling material in order to achieve a smooth crop flow into the pick up unit. The crop roller height should be adjusted, by engaging the chain-links in the keyhole slots, so that the stops do not rest on the rubber bumpers as shown. Once this initial height is set, it is then self adjusting depending on crop conditions. Ensure linchpins are used to secure chain links together. Once adjusted, the crop roller should run along the top of the

McHale Fusion Vario Baler & Wrapper

swath. In lighter conditions it should be adjusted as low as possible, but still ensure that the stops do not rest on the rubber bumpers.



Figure 10.c - Crop roller adjustment chain

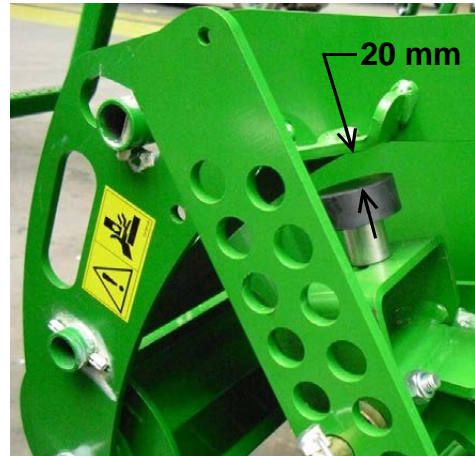

Figure 10.d - Crop roller stops

10.5 Unblocking system

The **McHale Fusion Vario** is equipped with an unblock system. In the case of a blockage in the feeding channel, the PTO overload clutch will disengage and a loud clicking noise will be heard. Once this sound is heard, immediately turn off the tractor PTO and push “Unblock” (Button R2) on the control box for three seconds, while in the Automatic cycle. This will start the unblock routine and the knives, if set to ON, will retract along with the channel floor. Then restart the tractor PTO at a slow speed, increasing speed slowly up to 540 rpm and not exceeding 610 rpm. Any lumps of material will now be easily transported into the bale chamber.

After having cleared the blockage, a quick push of “reset” (Button R2) will return the channel floor to the working position, followed by the knives, if previously set to ON.



WARNING: Never go near the pick-up reel, while the reel is still rotating and the tractor is running!

Never attempt to go near the pick-up reel while the reel is still rotating and the tractor is running. In the rare case that the reel cannot be unblocked using the procedure above, then the pickup reel will require manual unblocking, by removing the excess blocked material. To do this safely ensure the PTO is disengaged, tractor shut down, key removed and that all parts have stopped rotating. Also ensure machinery can't roll by parking machinery on level ground with the brakes applied and wheels chocked. Remove excess material carefully. Always wear protective clothing and gloves, beware of sharp edges!



Figure 10.e - Unblock mode, knives retracted and channel floor lowered

10.6 Chopping system

The **McHale Fusion Vario** is equipped with a 15 (or 25) knife chopping system. All of the knives can be removed, if desired, see “Chopper unit knife removal & installation” on page 43. The knife buttons on the control box will move the knives into the feeding channel or retract them. It is recommended to switch the chopping device off when baling very dry material.

In order to protect the chopping device against overload and damage, hydraulic accumulators are connected to the actuation circuit.



NOTE: Keep the knife slots clear of material

To keep the knife slots clear of material, it is recommended to switch the knives on and off several times daily. To do this, press “knife selection” once (Button R1), while the control box is in automatic mode. This will move the knives to the opposite position. One more press will move the knives back to the original position. See “Knives operation” on page 60 for proper control unit operation of the knives.

10.7 Selectable knives

Selectable knives are an option on the **McHale Fusion Vario** Baler & Wrapper. The operator can select between 0, 7, 8 or 15 (0, 12, 13 or 25 with 25 knife option) from the control box. The knives must be fully down, before selecting the desired set of knives. See Section “Knives operation” on page 60.



Figure 10.f - Selectable knives

10.8 Bale density gauge

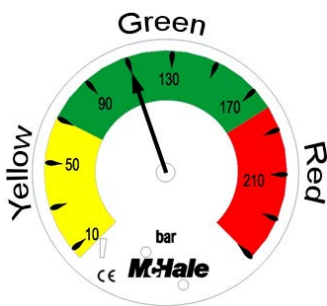

The bale density gauge is used to indicate the pressure applied to the belt tension rams (on the small side). When the tailgate is closed, and no material in the baling chamber, the pressure shown on the gauge is known as “starting pressure”. This pressure will then increase due to the oil in the cylinders being forced through the density valve as material begins to fill up the baling chamber. For the first 500 mm of the bale the density will rise to the core density setting and after that the needle should rise to the set bale density and remain there until the bale is complete. Pressure should never go above 200 bar, if it does consult your **McHale** dealer.

10.9 Tailgate safety lock

The tailgate safety lock should be used at all times that the operator may wish to enter the chamber, for example to change the cutter knives. The lock (A) is located on the front right hand side of the platform, at the front of the machine. See below for the safety decal and location of the tailgate safety lock valve. The lock works by way of a hydraulic on/off valve, while locked the valve is in the “off” (vertical) position and the hydraulic rams will remain locked open, securing the door in a fixed position.



WARNING: The operator must be aware of all related warnings, safety decals and dangers

The operator must be aware of all related warnings, safety decals and dangers before attempting to carry out any work or maintenance from within the baling chamber. Please refer to and follow carefully “Chopper unit knife removal & installation” on page 43 for instructions on how to enter the baling chamber.

To lock, pull lever (A) forwards and rotate down 90°, to the left vertical position.



Figure 10.g - Tailgate safety lock



Figure 10.h - Tailgate safety lock decal

10.10 Spare film holders & door latch safety

The **McHale Fusion Vario** can hold up to 12 rolls of spare film along with 1 more in each of the two dispensers. The spare rolls are stored at each side of the machine, behind the front panels. To open the primary latch (A) on the door panels, a 13 mm spanner or flat blade screwdriver will be required. The secondary latch (B) is opened by pushing it inwards to release the panel. (See Figure 10.i)

To store film rolls carefully, pull down film holders and slide the film roll core onto the film holder. Each holder stores two rolls of film each. Push the film rolls back into an upright position. The film holders are secured by a linch-pin which must be removed and replaced after use.



WARNING: Beware of falling stored objects behind door panels

Beware of falling plastic film rolls and other stored objects when opening door panels, especially when the machine is not on level ground!



Figure 10.i - Safety latch types

10.11 Net tension adjustment setting



WARNING: Ensure the tractor is shut down before adjusting

Never adjust the net tension while the baler PTO shaft is engaged or while the tractor is running. Shut down tractor, remove key and apply parking brake.

The tension on the net is achieved by means of a variable pulley. The net can be tensioned from 0% to 7% stretch, depending on the quality of net used and the percentage dry matter (%DM) of the material being baled. The machines are pre-set at 2% stretch. **McHale** recommend using a lower percentage stretch when baling dry matter material like hay and straw and a higher percentage stretch for material like grass.

These percentages will vary depending on bale density and type of crop being baled.



NOTE: Replace V-belt periodically

The belt tension needs to be checked weekly or after every 1,000 bales. The variable pulley V-belt must be replaced periodically by ordering Part No. CBE00246 (Type B83).



CAUTION: Use protective gloves

Wear protective gloves and clothing when carrying out these adjustments. Always exercise care when removing and fitting belts onto pulley wheels.

The following steps show how to adjust the variable pulley:



1. Using a 13 mm spanner, remove the guard covering the adjustable pulley by opening the three M8 bolts, as shown opposite.

McHale Fusion Vario Baler & Wrapper

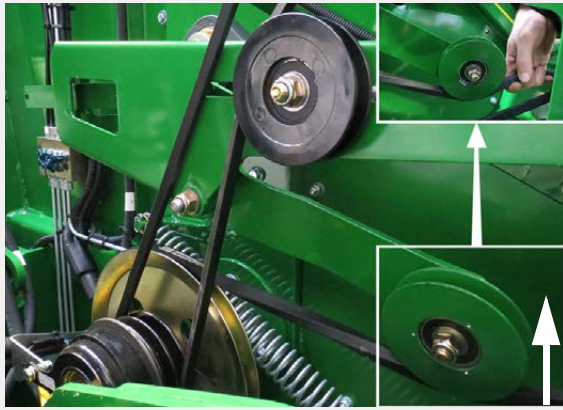

2. Tension is removed from the inner belt by grabbing the belt in front of the pulley and pulling upwards until the spring-loaded pulley latches, as shown in the next picture.

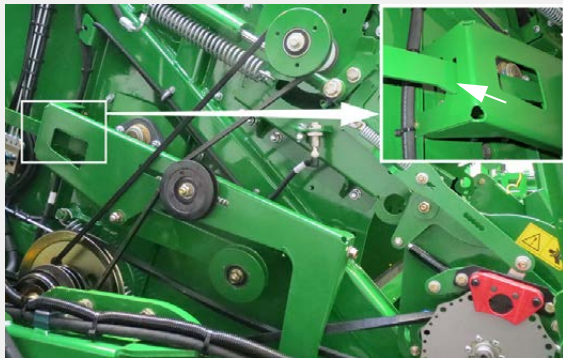

3. Once the pulley is latched as shown, the belt is now loose, allowing adjustments to be made to either the variable pulley or the brake caliper, as instructed.



4. The variable pulley is in two halves, with one side threaded into the other. The outer pulley is secured in place using two M8 grub screws tightened onto the flats of the inner pulley.

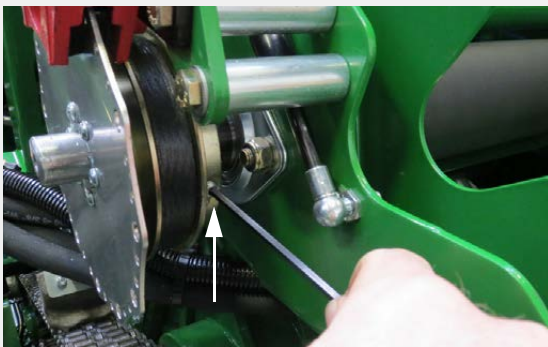

5. Locate the two M8 grub screws on the adjustable pulley and loosen both back 6 turns, using a 4 mm allen key, as shown.

With the grub screws loosened, the pulley halves can be threaded inwards or outwards depending on the net tension required

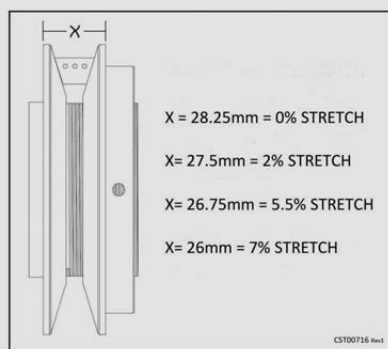

6. By referencing the diagram, the desired net tension can be achieved by adjusting the distance 'x' as indicated in the diagram. With the required tension setting achieved, tighten the grub screws.
WARNING: Ensure that the grub screws are tightened onto the flats on the inner pulley and not on the threads.



7. Once adjustments are completed then the inner belt can be re-tensioned as follows. Since the belt has a twist, care must be taken to ensure the V of the belt is pulled up into the V of the spring loaded pulley and whilst still holding the belt, with one hand, lift the latch with the other hand. As soon as the latch is tripped, the belt is re-tensioned automatically. Finally, replace the guard using the three M8 bolts.

10.12 Net brake adjustment

The net brake is designed to prevent net run-on and is applied immediately the net-knife trips. If problems exist with net run-on, or if net is being drawn into the chamber while baling, then it is likely that the brake needs adjusting.



WARNING: Ensure safety before working on brake adjustment

Before attempting to carry out brake adjustment, ensure that the tractor engine has been switched off, the key removed and the brakes applied.



WARNING: Wear proper safety equipment & follow all instructions

Always wear protective clothing and gloves, beware of sharp edges! Caution must always be taken when making adjustments in this area as the netter knife is extremely sharp!

After every 1,500 to 2,000 bales, a quick check should be carried out as follows: Firstly tension must be removed from the inner belt. (See Net tension adjustment setting)

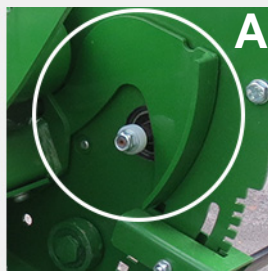
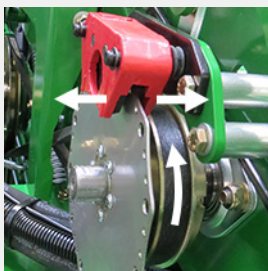

A. Net knife reset: The brake should be off in this position. Disc moves freely.

With the net knife in the re-set position as shown, it should be possible to rotate the brake disc freely, without the brake causing any noticeable drag.

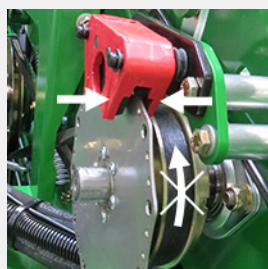

B. Net knife tripped: The brake should be on in this position. Disc is locked.

With the net knife in the tripped position as shown, it should not be possible to rotate the brake disc, without exerting a lot of force.

McHale Fusion Vario Baler & Wrapper

If the above conditions are not met, then adjust using the following procedure:

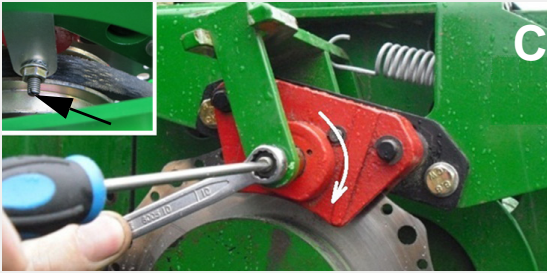

C. Adjustment: Insert a flat blade screwdriver in the screw slot and use a 10 mm spanner to loosen off the M6 nut, as shown. Then using the screwdriver turn the screw clockwise to tighten (apply the brake sooner) and anti-clockwise to loosen (back the brake off). Adjust the brake using only a ¼ turn at a time, as it is quite sensitive.

The brake should be set so that it is as close to the disc, as possible, without causing any drag. Tighten the M6 nut, holding the screwdriver in screw slot to stop it turning.

After performing an adjustment, carry out above checks at A and B to ensure brake is fully off, at step A and fully on, at step B. If not, repeat adjustment C until conditions at A and B are satisfied. A small movement of the brake arm should apply the brake fully. Finally re-tension inner belt. (See Net tension adjustment setting)

10.13 Brakes (Air/Hydraulic)

Machines fitted with brakes, either air or hydraulic, must be initially checked after the first 50 hours of use and every 100 hours or yearly thereafter (whichever comes first).



WARNING: Ensure safety before working on brake adjustment

Before attempting to carry out brake adjustment, ensure that the tractor engine has been switched off and the key removed. Testing should be conducted with handbrake 'off' on both baler and tractor and a second trained person will be required to activate brakes from the tractor. Also ensure machinery can't roll by parking machinery on level ground with wheels chocked.



WARNING: Always wear protective clothing and gloves

Always wear protective clothing and gloves.

McHale Fusion Vario Baler & Wrapper

The following is the procedure for checking brakes:

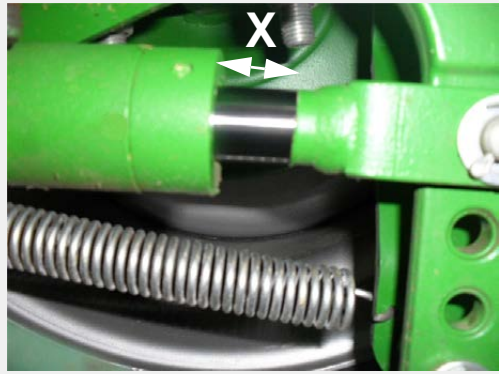

1. Check dimension 'X' before applying brakes and again when brakes are applied. The value for 'X' should be between 12 and 18 mm.

On hydraulic brakes (top picture) this is usually the amount of exposed chrome visible on cylinder rod.

On air-brake systems (bottom picture), some fixed reference point must be used to measure the actuator movement.

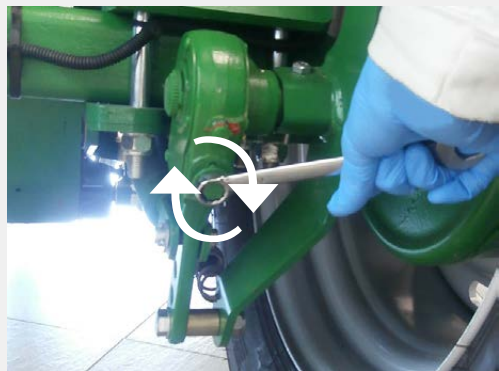
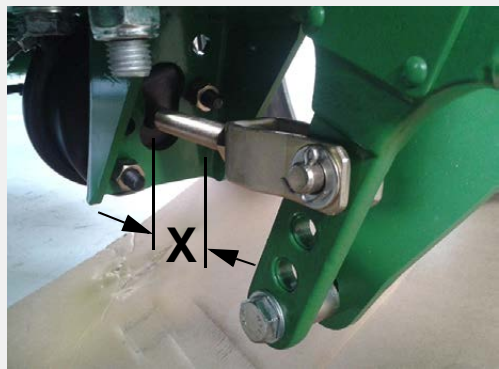

2. If the value for 'X' is not within this 12 to 18 mm range, then the brake can be adjusted using the adjuster screw, as shown. Using a 14 mm spanner, turn the adjuster screw clockwise to reduce the value and anti-clockwise to increase. Apply the brake again to check the measurement and repeat this procedure until the movement is within the designated range.

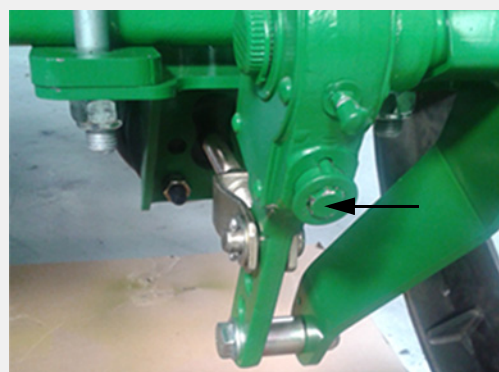

3. Ensure the spring-loaded locking collar is returned, to the locked position, to prevent any further movement of the adjuster screw.

Repeat the procedure for both sides of the machine and ensure brakes are being applied evenly. Both sides should be adjusted as closely as possible to the exact same value.

10.14 Adjusting pick-up float springs

The spring retained collars which are used to adjust the pick-up float springs are located on either side, underneath the chopper unit, see Figure 10.k below. To adjust, follow the procedure below:

1. Using the tractor spool handle, hydraulically raise the pick-up, in order to release float spring pressure.
2. Ensure that the tractor engine has been shut down, the key removed and the brakes applied before carrying out the following procedure.
3. The method of adjustment can be either Type A or Type B, which are shown below.
 - (a) **Type A:** Loosen the collar by slacking off the bolts (2 arrows, See Figure 10.j), then tap the collar in the direction (R) if increased float is required, or in direction (F) if less float is required. Remember to fully tighten the bolts on the collar when adjustment is complete.
 - (b) **Type B:** Loosen the collar by moving the circlip to another groove (See Figure 10.l). The ram body on type B has a series of grooves allowing the circlip and collar to be moved at 10 mm intervals of adjustment. Tap the collar in the direction (R) if increased float is required, or in direction (F) if less float is required. Ensure circlip is positioned fully in the nearest groove to complete adjustment.
4. Lower the pick-up reel. Both left-hand and right-hand 'float spring' rams should be adjusted in exactly the same way so that the load is balanced and equal.



NOTE: Adjustment should enable the pick-up to drop completely

This adjustment should enable the pick-up to drop completely, while in the lowered position. If not, re-adjust by lowering the spring tension, i.e. move the collar in direction (F).



NOTE: Additional spring force required when operating at heights

If operating at heights other than the fully lowered position, then additional spring force will be required to obtain adequate float, i.e. move the collar in direction (R).

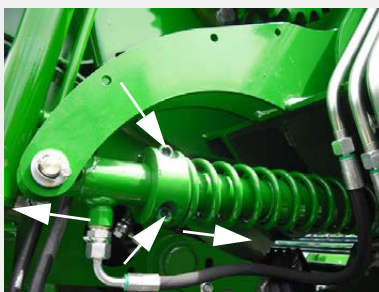

Figure 10.j - Type A

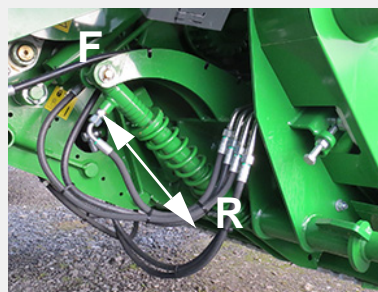

Figure 10.k - Adjustment of pick-up float springs



Figure 10.l - Type B



WARNING: Ensure spool control lever is in the 'float' position

When baling with this machine, ensure that the control lever for the spool operating the pick-up reel height adjustment is in the 'float' position. If the lever is not in the float position, then the reel will be fixed in a set position and unable to follow the ground contours.

10.15 Chain adjustments

It is important for the efficient operation of the machine that all drive chains are kept correctly tensioned. The following is a general guide to chain adjustment.

The sag is measured at the midpoint of the chain between the sprockets. Always ensure one side of the chain is tight so that the correct reading is obtained. Even though some drives differ in detail the basic adjustments stay the same.

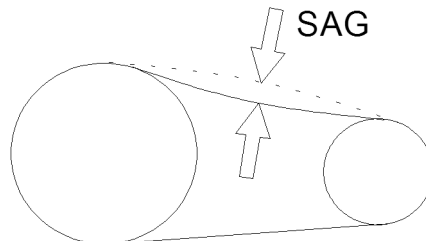

Figure 10.m - Chain adjustments

All roller chain adjustments will require two 19 mm spanners for adjustment, unless otherwise stated. The following chains will require an inspection for sagging after the first 500 bales and must be inspected once per 1,000 bales after that.

10.15.1 Main drive chain adjustment

Adjust turn buckle (A) until the gap between the coils of the spring is 2-3 mm. As the chain wears the gap (D) will need to be reduced. If there is no more adjustment available in the turn buckle (A) the end of spring (B) can be moved to location (C) on the chain tensioner bracket.

Always inspect the chain tension after adjustment.

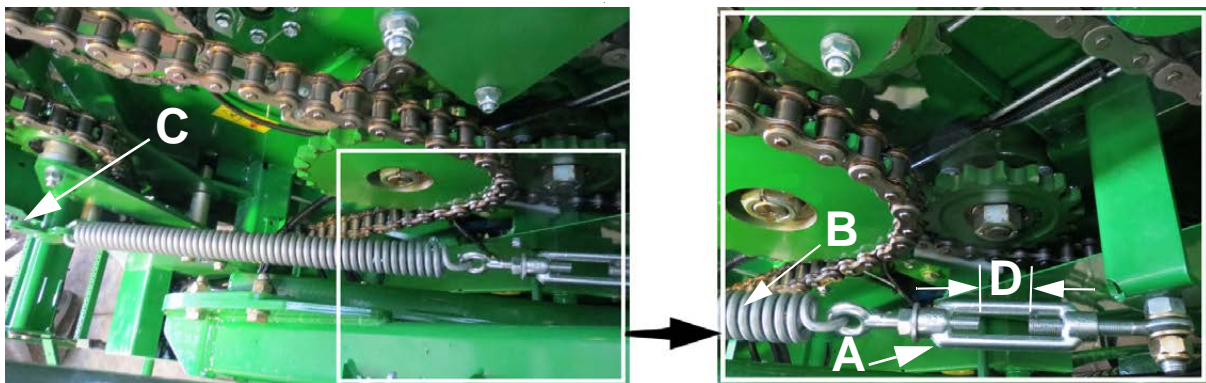

Figure 10.n - Adjustment of main drive chain

10.15.2 Pick-up reel tine chain adjustment

To adjust the tine reel chain, the use of a 17 mm spanner and socket is required.

1. Loosen (A) and turn tine sprocket (D) anticlockwise, as shown below.
2. Apply upward pressure (along slot B) to nylon chain slide (C), while continuing to hold sprocket (D) in position.
3. Tighten (A) and ensure that sagging is kept to a minimum.

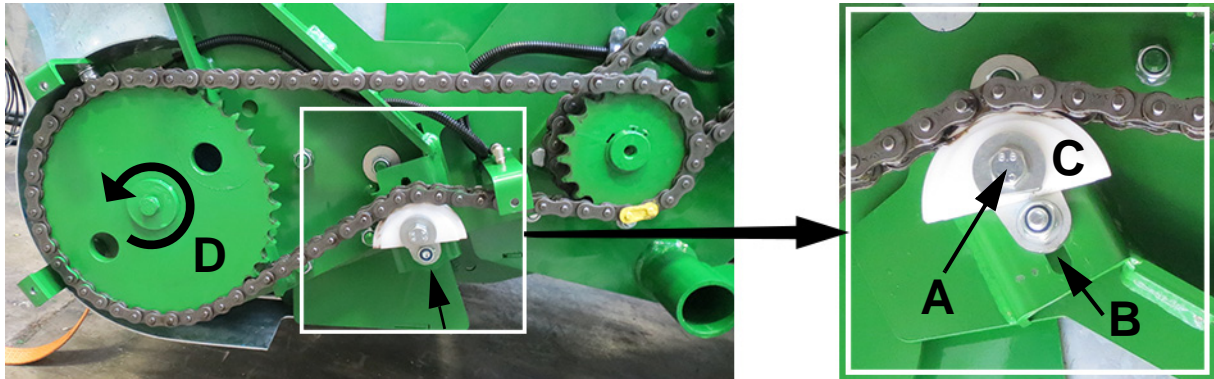

Figure 10.o - Pick-up reel tine chain adjustment

10.15.3 Reel drive chain adjustment

To adjust the reel drive chain the use of both a 17 mm and 19 mm spanner and socket are required:

1. Using 17 mm tools, loosen (A) anti-clockwise by approx.1 turn.
2. Using a 19 mm spanner, loosen locknut (B).
3. Tighten setscrew (C) until there is little or no sagging of the chain and retighten bolt (A).
4. Retighten locknut (B).

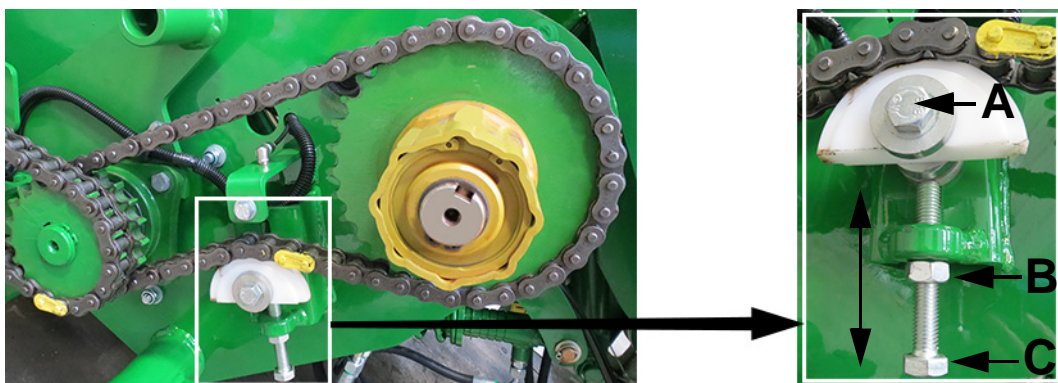

Figure 10.p - Reel drive chain adjustment

10.15.4 Chopper unit duplex chain adjustment

To adjust the duplex chain the following tools are required; two 24 mm spanners.

McHale Fusion Vario Baler & Wrapper

Follow the procedure below:

1. Hold the lower nut and loosen the upper nut.
2. To tighten - screw down the lower nut in the direction T.
3. When the chain is at the required tension, screw down the upper nut.
4. Lock the two nuts together to secure in place.



Figure 10.q - Chopper unit duplex chain adjustment

10.15.5 Cleaning roller drive chain adjustment

To adjust the chain, the following tools are required; 17 mm spanner and a 17 mm socket and ratchet.

1. Remove the bolt (B) from the locking plate (C).
2. Using the socket loosen the bolt on the back of the tensioner (A). This bolt is accessed through a hole in the chamber wall.
3. To tighten the chain rotate the body of the tensioner in an anti-clockwise direction.
4. Tighten the bolt on the back of the tensioner (A) when the desired tension is reached and refit the bolt (B) to the locking plate (C)



NOTE: Chain is factory fitted with a half link, which may be removed

When leaving the factory, this chain is fitted with a half link. After the machine has been worked the chain will stretch and it may be necessary to remove this link.

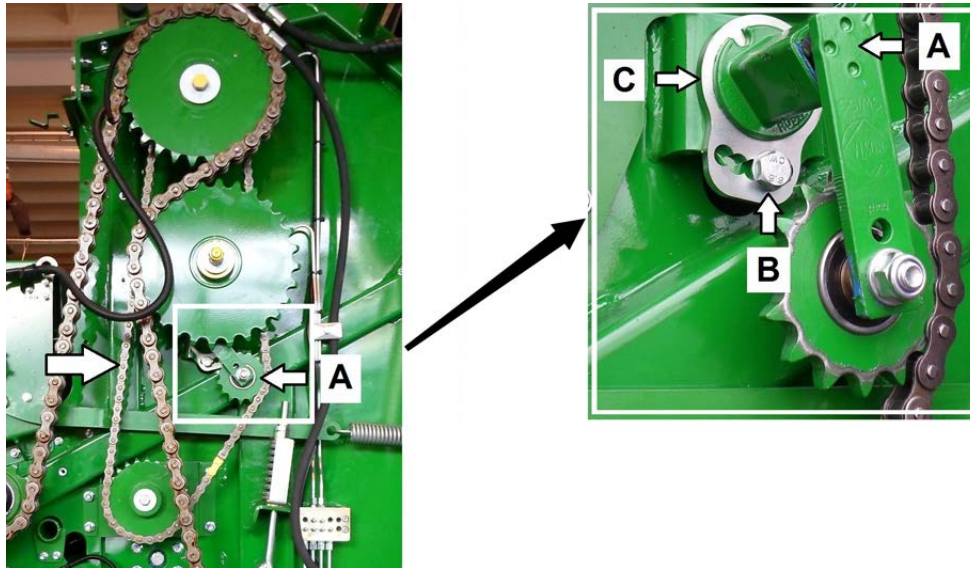

Figure 10.r - Cleaning roller drive chain adjustment

10.16 Adjusting belt alignment

This is done by adjusting the belt tracking roller which is located at the lower back corner of the tailgate (See Figure 10.t).

Check the direction (right or left) in which the belts have moved. This is most easily seen on either the top tension arm roller or the tracking roller itself.

Assuming crop is fed evenly into the bale-chamber, generating consistent good profile bales, the belts should run smoothly and remain in-line. All machines are checked during production, to ensure the belts are properly aligned and tracking correctly. However once the machine has been bedded in (50 - 150 bales) and periodically thereafter, if the belts are touching off the side-walls or each other, then adjustment may be necessary.

This check should be made with the tailgate opened approximately 30° (600 - 900 mm) to ensure belts are clear of other influencing factors, then close the tailgate safety lock 'A' immediately (See Section 10.9).



WARNING: Ensure safety first!

Ensure PTO is disengaged, tractor shut down, ignition key removed and tailgate safety lock closed before carrying out this procedure.

Before carrying out the following procedure, make sure that the bale chamber is empty and that all rollers and belts are free of any loose debris or crop.

The bottom roller on the tailgate has adjusters on each end to alter tracking.

1. Adjustment should only be necessary on one end of roller. (i.e. either left or right-hand side)
2. Firstly loosen bolt B using a 24 mm A/F socket or spanner and back off just a few millimetres.
3. Using a 19 mm open-end spanner, back off locknuts (C & D), as shown below.

McHale Fusion Vario Baler & Wrapper

4. By adjusting locknut C or D, the roller centre can be moved either rearwards (R) or forwards (F).
5. Moving the roller-end forwards will encourage the belts away from the side being adjusted and moving the roller-end rearwards will encourage the belts towards that side.
6. Once adjusted, tighten the remaining locknut and with the 'Danger Zone' clear, run the machine to see if the belts are tracking evenly. If not, repeat steps 1 through 4 (ensuring tractor is shut down, PTO disengaged and ignition key removed) until tracking is aligned.
7. Finally, tighten bolt B to a torque of 280 Nm.

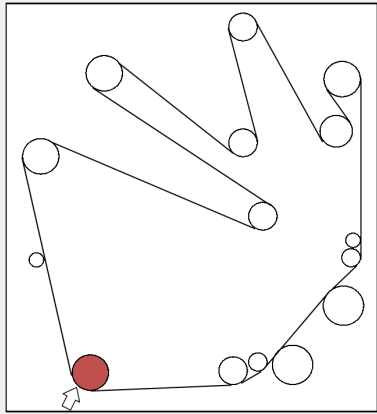

Figure 10.s - Belt tracking roller location

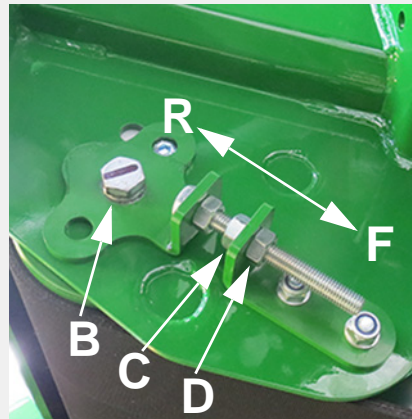

Figure 10.t - Tracking roller adjustment

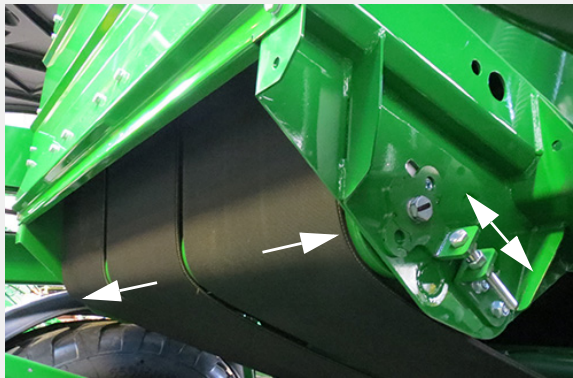
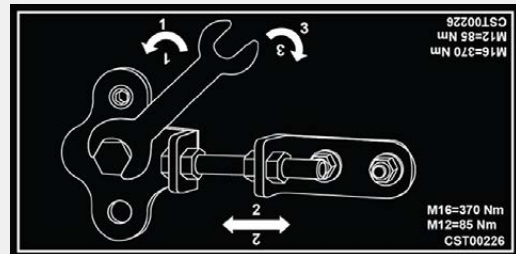

Figure 10.u - Checking belt alignment



When adjustment is complete, open the tailgate lock 'A' (See Section 10.9) then close the tailgate and baling can resume as normal.

11

Accessories & optional equipment

Certain accessories and optional equipment may or may not be available in all countries, depending on varying circumstances. The following key symbols help to explain what is sold as standard and what is optional equipment, or may not be available on the **McHale Fusion Vario**. They are only correct at the time of print and may vary.

Key symbols	
Standard equipment	●
Optional equipment	⊙

11.1 Drawbar hitch options

Low drawbar hitch ●

Depending on the country of use this drawbar type is standard, but the high drawbar hitch is available as an option.

High drawbar hitch ⊙

Depending on the country of use this drawbar type is standard, but the low drawbar hitch is available as an option.

11.2 Stand options

Stand type A ●

This is a static swing-down stand (fixed) and is suitable for use on the low drawbar hitch only!

Stand type B ⊙

This is a hand operated swing-down stand (adjustable screw) and is suitable for raising or lowering the machine for tractors that have static drawbar hitches. This stand type is available on the low drawbar hitch only.

Stand type C ⊙

This is a hand operated fixed stand (adjustable screw) that comes as standard on the high drawbar hitch option. This is raised and lowered by means of a crank-handle.

11.3 Brake options

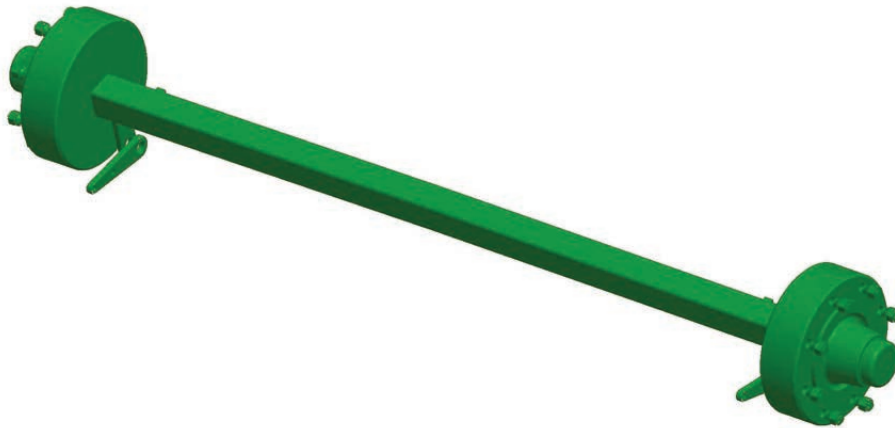

Figure 11.a - Braked Axle

Hydraulic brakes ●

This system utilises one hose for connection to the tractor's hydraulic brake coupling. This is the most common braking system on the machine.

Air brakes ⊙

This system utilises two air brake couplings and the use of which may be mandatory in certain countries. Always obey local road regulations!

11.4 Side tip option ⊙

The side tip option is used for knocking the bale onto its side and is very useful for coarse ground with strong stubble (which may have a tendency to puncture the film), as it allows the bale to land on its edge, which has a much higher degree of film coverage. It is also very useful on hilly/sloping ground as it can prevent bales from rolling, when they land on their side. The side tip is attached to the rear wrapping cradle.

11.5 Selectable knives ⊙

This system gives the operator the option of using 0, 7, 8 or 15 knives (0, 12, 13 or 25 with 25 knife option).



Figure 11.b - Selectable knife chopper unit

11.6 Crop roller ●

The crop roller aids the crop transfer from the pick-up reel in to the rotor.

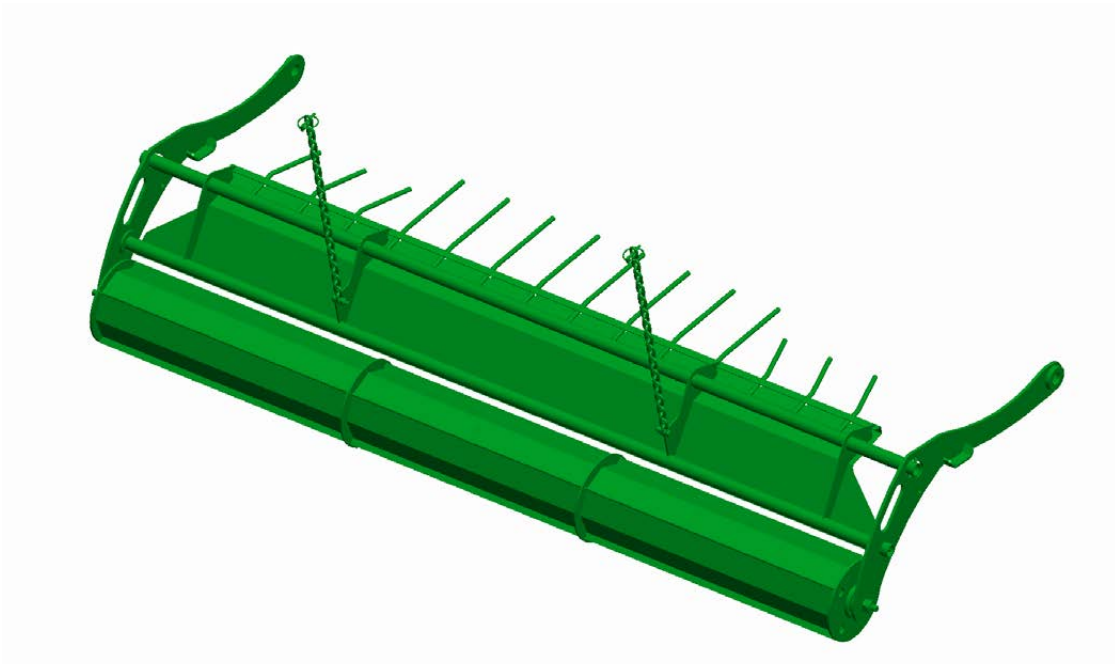
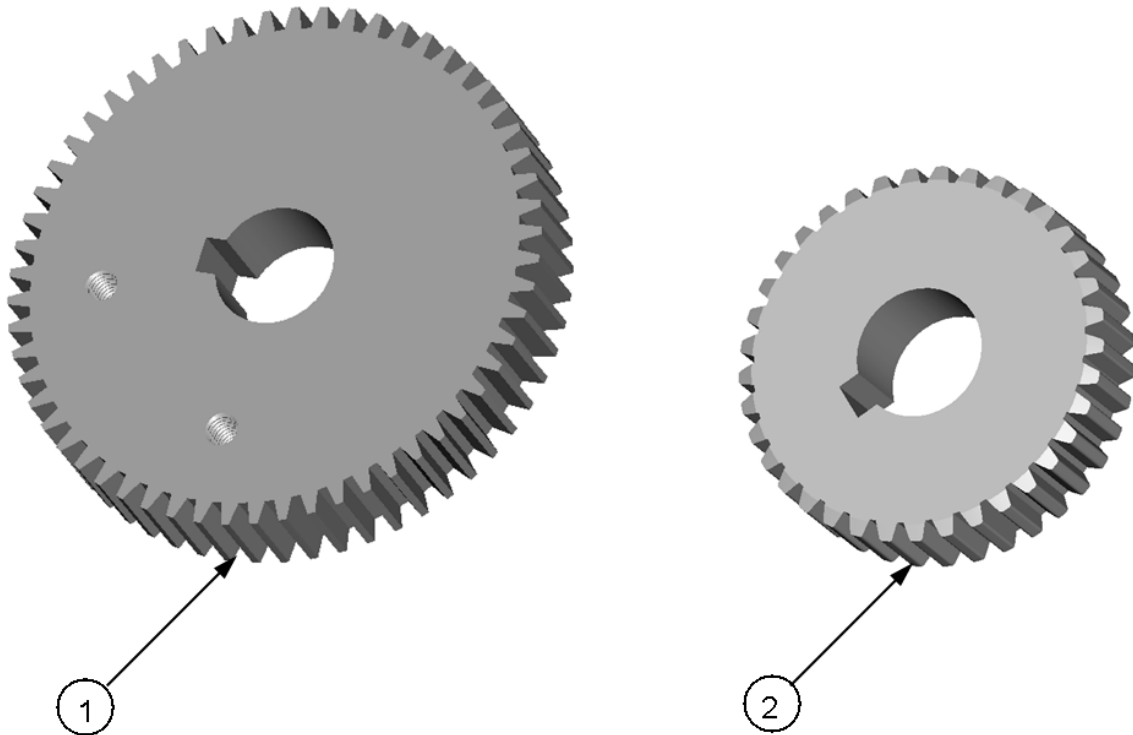

Figure 11.c - Crop Roller

11.7 Dispenser gear options



70% Gear option ●

Item	Part Code	Description	Qty
	ADP00018	Kit dispenser gears 70%	1
1	CMH00055	Gear spur 1.5 m 60 t dispenser	1
2	CMH00175	Gear spur 1.5 m 35 t dispenser	1

64% Gear option ○

Item	Part Code	Description	Qty
	ADP00020	Kit dispenser gears 64%	1
1	CMH00056	Gear spur 1.5 m 59 t dispenser	1
2	CMH00096	Gear spur 1.5 m 36 t dispenser	1

55% Gear option (Hot climates) ○

Item	Part Code	Description	Qty
	ADP00019	Kit dispenser gears 55%	1
1	CMH00057	Gear spur 1.5 m 58 t dispenser	1
2	CMH00174	Gear spur 1.5 m 37 t dispenser	1

12

Attachments

12.1 Side-tip

When the machine tips off the wrapped bale, the outer wrapper roller moves down to ground level and ejects the bale. This eliminates problems associated with bales being tipped from a height and getting damaged as they roll away.

In stalky crops or on rougher ground conditions a side-tip option is available which allows the machine to tip the bales on their ends where there is additional film.



Operating your machine with side-tip

Once the side-tip frame is assembled to the machine, it will operate automatically without any operator input. As each wrapping cycle is completed, the operator must ensure that a clear and sufficiently large landing area is available for the bale. The hydraulic flow rate can be adjusted to modulate the speed at which the rear cradle and side-tip moves using the operator adjustable flow-restrictor valve (CVA00276) mounted under the main hydraulic valve. **(P)**

Safety

Always ensure that there are no persons behind or around the wrapper during operation and unloading. It must also be noted that the side-tip frame adds 1.7 m to the overall length of the machine. Always allow for the tail swing when turning the machine and side-tip frame. Beware of projection distance to the rear of the machine, when reversing, a side-tip attachment greatly increases the length of the machine. See serial plate for details.

Road transport

The side-tip must not be used on public roadways and must always be folded vertically beforehand. It is not to be used in fields or on roads at speeds above 20 km/h. It must be ascertained first that road regulations in the country of use allow you to transport the side-tip frame behind the machine.

Fitting the side-tip to the machine

1. It may be easier when fitting the side-tip to lower the rear cradle halfway down. Ensure that the tractor engine has been shut down, the ignition key removed and the brakes applied.
2. Secure the rear roller, using suitable lifting gear. Remove the rear cradle roller chain guard. **(A)** Remove the M10 x 25 bolt from the end of the rear roller sprocket. **(B)** Rotate the rear roller manually to locate the joiner link in the drive chain. Remove the link and chain.
3. Pull the sprocket out on the end of the shaft, as far as possible. **(C)**

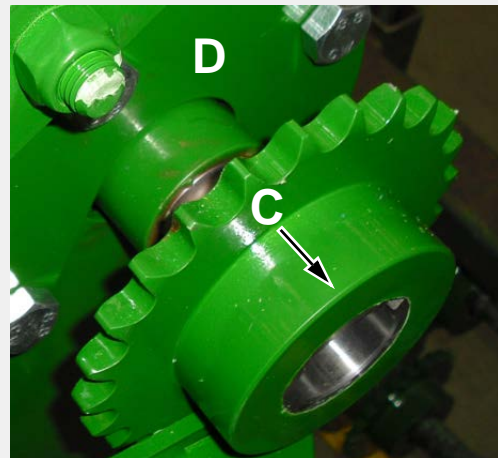
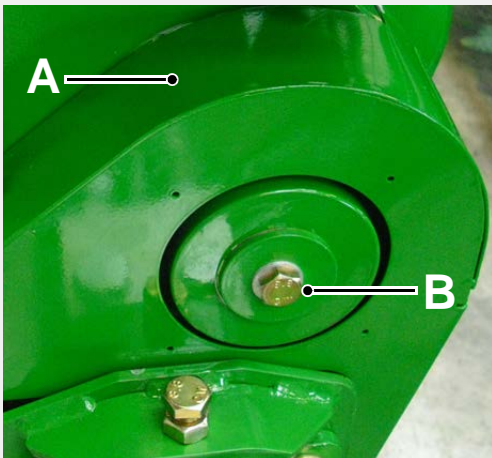

4. Remove the four M16 nuts and bolts, which hold the flange bearing. Fit the right hinge mounting bracket (ACH01347) using four M16 x 55 bolts (CFA00349) and nyloc nuts. **(D)** Ensure bolts are tightened fully.
5. Refit the sprocket and secure using the M10 x 25 bolt. **(E)** Refit the drive chain and joiner link. **(F)**
6. Refit the rear cradle roller chain guard, having removed the pop-out section to allow for the new bracket. **(G)**

McHale Fusion Vario Baler & Wrapper

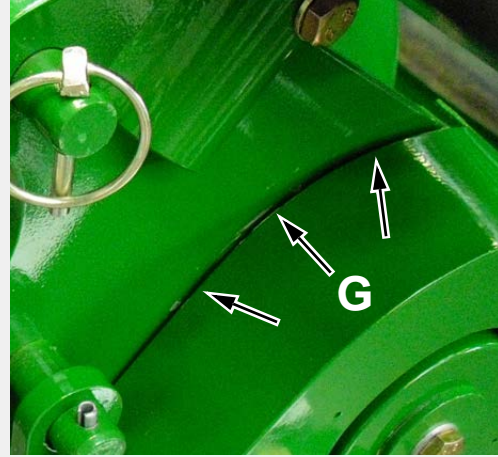
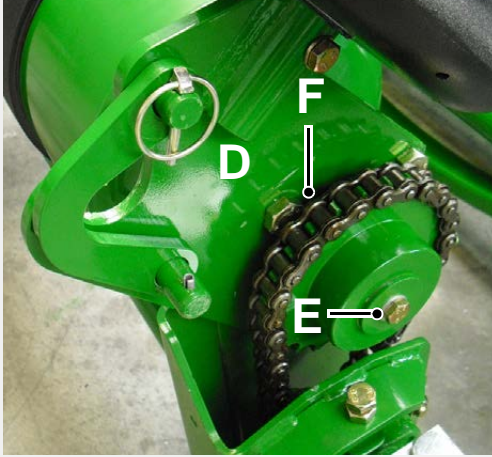

7. To fit the left mounting bracket (ACH01346) to the idle end of the roller, remove the four M16 nuts and bolts.
8. Fit the bracket, using four M16 x 55 bolts (CFA00349) and nyloc nuts. (H) Ensure bolts are tightened fully.

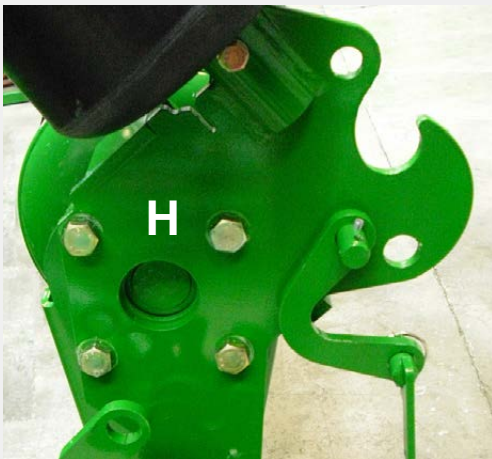

9. Fit U-shaped mounting plates (CZH04868), for the suspension unit to brackets on left side of the cradle, using the bushings and fasteners supplied. (I)

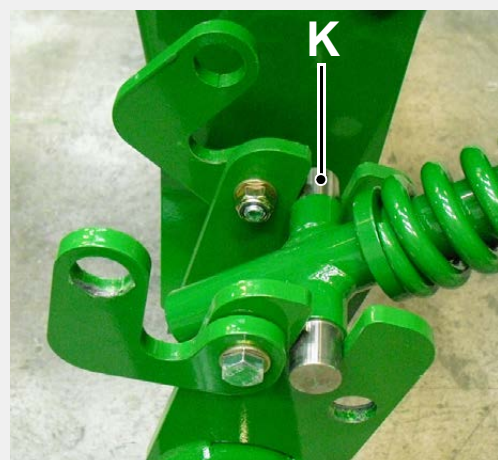

10. Using suitable lifting gear (J), place the side-tip frame assembly down into the mounting brackets, beginning with the suspension cylinder pivot. (K) Next, lower both the left and right main pivots onto the cradle brackets. (L & M)

McHale Fusion Vario Baler & Wrapper

11. Swing both V-shaped plates (CZH03852) over the main side-tip pivots on the left and right mounting brackets and secure onto the stub shafts using linch pins. **(N)**

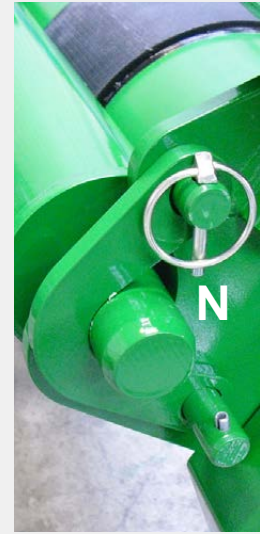
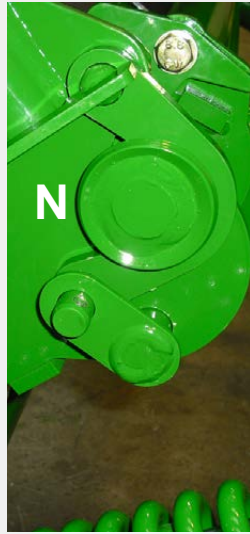

12. Swing both U-shaped plates over the suspension cylinder pivot and secure using the latch pin (ABD00080) and linch pin. **(O)**

13. Fit the flow-restrictor valve (CVA00276) under the main hydraulic valve, as shown, by removing the cradle supply hose and mounting valve, fittings and washers. **(P)** Once the machine is up and running, this valve can be adjusted to give the desired lowering speed for the rear cradle & side-tip combination.

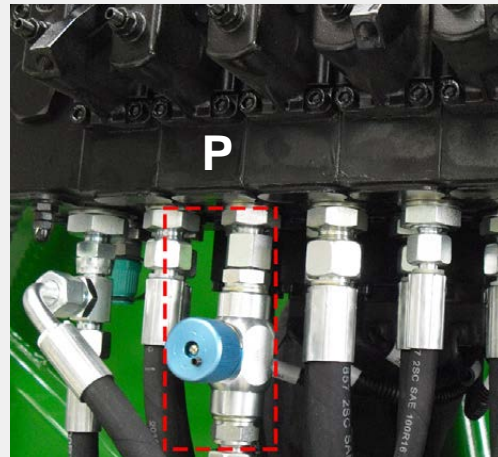

14. Panel guards are provided to ensure that the wrapped bale is protected, from sharp edges, as it exits the machine. **(Q & R)** Fit panel guards to the left and right sides of the machines, using three M10 x 35 setscrews.

McHale Fusion Vario Baler & Wrapper

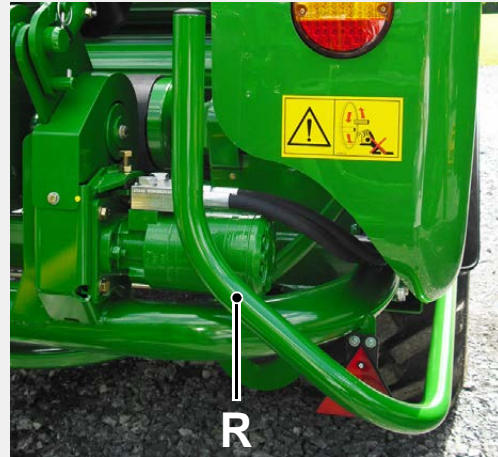

15. When the side-tip is being transported, the transport pin must be in the transport position. The transport pin must be removed from its storage position on the suspension mount (**S**) and repositioned into the transport position (**T**) on the rear cradle. Always use the linch pin to secure the transport pin in either location.

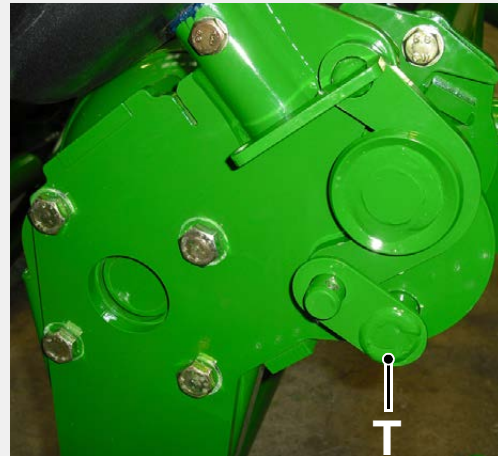
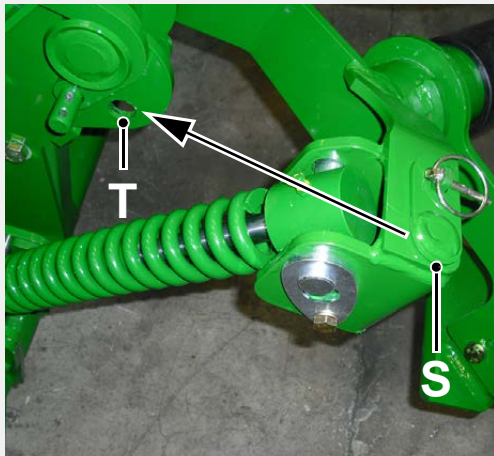

16. Once the rear cradle is raised to the home position the side-tip is automatically swung into the vertical transport position, allowing it to be transported safely, as shown below.



13

Machine maintenance

To maintain the **McHale Fusion Vario** in good working order it is necessary to carry out preventative maintenance regularly. The following section gives details of how this may be carried out and how often it will be required.



ENVIRONMENT: Health and safety rules for the environment

It is vitally important to observe health and safety rules in order to avoid unnecessary environmental damage or danger to anybody near the machine. This especially applies to the responsible disposal of oil. Never spill pollutants (oil, grease, filters, etc.) on the ground, never pour them down the drain and never discard them where they can pollute the environment. Always take waste materials to a recycling centre.

13.1 Maintenance intervals

The following intervals should be adhered to, in order to ensure a long and efficient life for the machine and maximum safety of personnel. They assume constant working during the harvesting season.

First 5 working hours

- Check all nuts and bolts for tightness and tighten, if necessary
- Ensure axle U-bolts are tightened to a torque of 450 Nm
- Check and correct, if necessary, the air pressure in the tyres
- Drain and change gear box oil (See Section “Gearbox oil” on page 49)
- Carry out adjustment of chopper unit duplex chain (See “Chopper unit duplex chain adjustment” on page 101) Inspect all other chains.

Every day

- Check wheel nuts
- Check all guards and safety devices
- Check road traffic equipment
- Check for any oil leaks and damaged pipes
- Fill chain lubrication container (300 bales approx.)
- Grease rear pivot points of transfer cradle
- Grease door hinge points
- Grease pick-up bearings
- Grease all roller bearings from central grease blocks

McHale Fusion Vario Baler & Wrapper

- Grease table roller pivots
- Check all chain adjustments, and adjust as necessary

Every week

- Grease PTO shaft every 60 working hours (see Section “PTO shaft adjustment & maintenance” on page 54)
- Check for correct air pressure in the tyres
- Grease table roller bearings
- Grease front and rear pivot points of transfer cradle

Every month

- Grease pick-up reel shaft bearings
- Grease pick-up cam clutch
- Check sufficient oil level in the gear box

Every year

- Clean and lubricate all moving parts of the netter unit
- Ensure axle U-bolts are tightened to a torque of 450 Nm
- Drain and change gear box oil (see Section “Gearbox oil” on page 49)
- Clean and lubricate dispenser gears

It may become necessary from time to time to clean the dispenser rollers as they pick up the “tack” from plastic film. Clean off with kerosene.

At the end of the baling season the machine should be washed and cleaned.

Carefully clean all machine sections, inside and out. Dirt and foreign objects are likely to draw moisture and cause rusting of steel components. **McHale** recommend that the machine be blown down with an air line, as opposed to a pressure washer, due to the dangers involved with pressure washing and to protect the overall paint work on the machine. If, despite our advice, a pressure washer is used then take extreme caution and operate from ground level only. Do not point pressurized water at or near electrical components, pivots points, valves or bearings. Never climb onto any part of the machine, while pressure washing, due to the fact that all metal surfaces become extremely wet and slippery and always ensure that the tractor has been shut down, with the ignition key removed.

Any damaged paintwork should be touched up. Any maintenance or repairs should be carried out at this stage. The electronic control box is not waterproof, so it must always be stored in a dry environment. All exposed hydraulic cylinder rods should be greased. The pick-up and the cutting device area as well as the bale chamber should be cleaned and lubricated, see “Storage” on page 118.



WARNING: Wear proper safety equipment & follow all instructions

Ensure to wear proper safety equipment at all times when working with the machine, such as gloves, eye protection, etc. and follow all safety decals and instructions

McHale Fusion Vario Baler & Wrapper



WARNING: Inspections in the “Danger Zone” during machine operation require a second trained operator at the controls

McHale recommend that nobody is ever in the “Danger Zone” at any time during machine operation, but in the event of carrying out inspections (contrary to our safety recommendations!) when the machine is in operation, there must always be a second operator at the tractor controls (who is fully competent in the operation of both the tractor and machine), in case an emergency stop action is required.

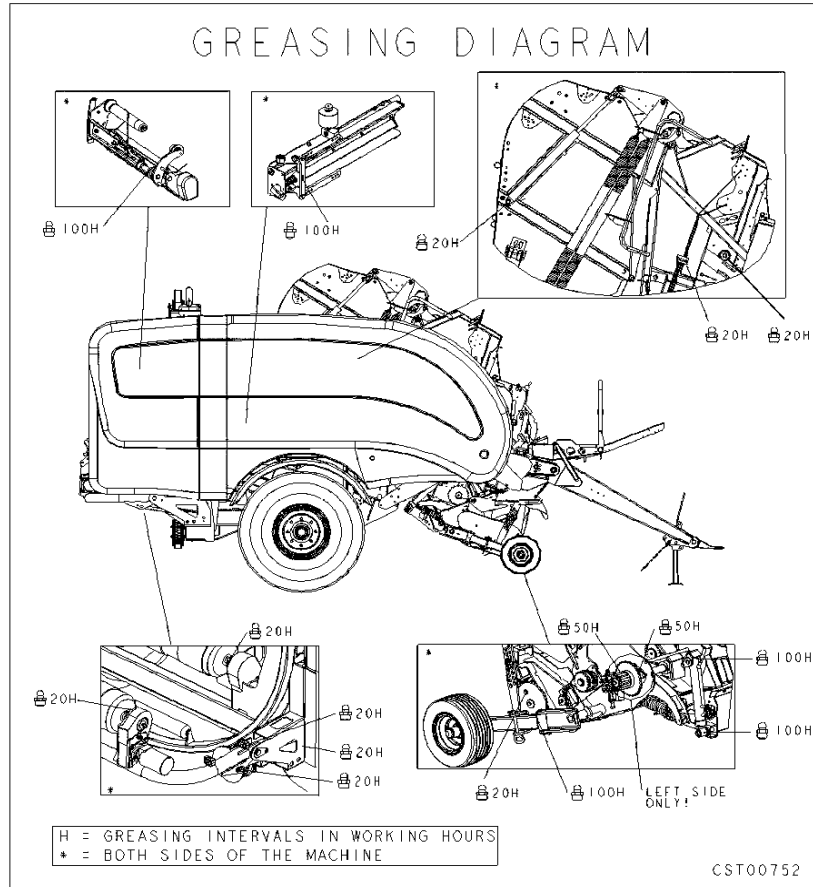

Figure 13.a - Greasing diagram

Additional greasing needs to be carried out as shown. This decal is mounted inside the front right panel on the right hand side of the tailgate. (CST00752).

13.2 Tightening torque values

It is important that the correct torques for fasteners are adhered to. Below are tables of recommended torques for these. These are to be used unless torques are otherwise specified. These values are for general use only. Check tightness of all fasteners periodically.

Nuts and bolts		Black, Phosphated or Galvanized		
Grade marking		8.8	10.9	12.9
	Dimensions	Metric standard thread		
Hex. bolts	M4	2.7	3.8	4.6
DIN 931	M5	5.5	8	9.5
DIN 933	M6	10	14	16
	M8	23	33	40
Socket head	M10	45	63	75
Cap screws	M12	78	110	130
DIN 912	M14	122	175	210
	M16	195	270	325
Hex. nuts	M18	260	370	440
DIN 934	M20	370	525	630
	M22	510	720	870
	M24	640	900	1,080
	M27	980	1,400	1,650
	M30	1,260	1,800	2,160
	Dimensions	Metric fine thread		
Hex. bolts	M8 x 1	25	35	42
DIN 960	M10 x 1.25	48	67	80
DIN 961	M12 x 1.25	88	125	150
	M12 x 1.5	82	113	140
Hex. nuts	M14 x 1.5	135	190	225
DIN 934	M16 x 1.5	210	290	345
	M18 x 1.5	300	415	505
	M20 x 1.5	415	585	700
	M22 x 1.5	560	785	945
	M24 x 2	720	1,000	1,200
	M27 x 2	1,050	1,500	1,800
	M30 x 2	1,450	2,050	2,500
NOTE:	For cadmium or copper plated bolts and nuts a torque value must be used that is lower than the value stated above			

14

Storage

14.1 End of season

- Carefully clean all machine sections, inside and out. Dirt and foreign objects are likely to draw moisture and cause rusting of steel components. **McHale** recommend that the machine be blown down with an air line, as opposed to a pressure washer, due to the dangers involved with pressure washing and to protect the overall paint work on the machine. If, despite our advice, a pressure washer is used then take extreme caution and operate from ground level only. Do not point pressurized water at or near electrical components, pivots points, valves or bearings. Never climb onto any part of the machine, while pressure washing, due to the fact that all metal surfaces become extremely wet and slippery and always ensure that the tractor has been shut down, with the ignition key removed.
- Remove control box from the tractor and store in a dry, safe environment
- Clean the net wrapping system, as described in Section “Care of the net wrapping system” on page 39. Remove net roll and store, as per manufacturers instructions. Grease net knife and cut and hold knives to prevent rusting, use extreme caution when carrying out this operation, ensure to wear protective gloves and clothing!
- Lubricate all pivot points and apply a thin layer of grease to all adjustment bolt threads and exposed ram rods.
- Check all oil and grease lines for damage and repair them if required.
- Any components from which paint has become worn should be touched up or coated with grease to prevent rusting.
- Remove all dirt from all chains and blow dry using compressed air.
- Fill chain oil reservoir with chain oil and run PTO at approx. 200 rpm and with the control box in manual mode, operate the bale tip up & down for around 15 cycles, to ensure that all chains have a heavy coating of oil applied. Pump grease into all grease points and centralised grease blocks to ensure all bearings and joints are well lubricated.
- Remove the knives from the chopping unit to prevent them from sticking and store them in the spare knife holder.

14.2 Start of season

- Fully review this operators instruction manual
- Check and fill gear box oil level, if necessary (See Section “Gearbox oil” on page 49)
- Lubricate all pivot points
- Tighten all bolts, nuts and setscrews (Refer to Section “Tightening torque values” on page 117)
- Check air pressure of all tyres
- Connect control box and inspect for correct operation of all functions (See “Control box functions” on page 57)
- Inspect and modify, if necessary, all machine adjustments (See “Field operation & baler adjustments” on page 88)
- Remove the grease from the net knife and cut and hold knives. Use extreme caution when carrying out this operation, ensure to wear protective gloves and clothing!
- Check net wrapping adjustments and inspect net knife for sharpness, ensure to wear protective clothing whenever working in this area! See “Care of the net wrapping system” on page 39, follow instructions and carry out correct procedure.
- Inspect aluminium dispenser rollers for a build up of tack/glue, clean off using kerosene or diesel oil and wipe rollers dry.
- Fill chain oil reservoir with chain oil and run PTO at approx. 200 rpm and with the control box in manual mode, operate the bale tip up & down for around 15 cycles, to ensure that all chains have a heavy coating of oil applied. Pump grease into all grease points and centralised grease blocks to ensure all bearings and joints are well lubricated.

15

Troubleshooting

15.1 Troubleshooting overview

This section has been compiled by **McHale** Service Personnel in conjunction with **McHale** Importers and Dealers.

It outlines some common problems which can occur and acts as a quick reference section or check list to resolve the problem. It is important to note that it outlines the common problems and to this effect it is not exhaustive.

Should you experience additional problems which you need help with; please do not hesitate to contact your **McHale** dealer.

15.1.1 Machine using higher than expected horse power when chopping

Symptom	Reason	Solution
Machine using higher than expected horse power	Knives in chopper unit are blunt or bale density too high	Remove the knives, sharpen and replace

15.1.2 Pick up slip clutch going off easily

Symptom	Reason	Solution
Pick up slip clutch going off easily or machine breaking tines	Pick up set too close to the ground	Adjust the pick up to a higher position. Tines should not be getting caught in the ground.
Pick up slip clutch going off easily	Pick up chains loose	Tighten the pick up chains See "" on page 100

15.1.3 PTO slip clutch going off easily

Symptom	Reason	Solution
PTO slip clutch going off easily	Rotor chain loose	Tighten the rotor chain and check as specified
PTO slip clutch going off easily	Poor swath preparation	Prepare the swath in line with the recommendations in the machine set up
PTO slip clutch going off easily	Knives blunt	Check and sharpen if needed
PTO slip clutch going off easily	Chamber pressure/ground speed too high	Reduce

15.1.4 Knives not remaining up while chopping

Symptom	Reason	Solution
Knives not remaining up while chopping	Knives are blunt	Remove the knives and sharpen
Knife pressure too low		Refer to Section 15.1.5
Knives not remaining up while chopping	Roll Pins are broken in knife activator arms	Replace broken roll pins

15.1.5 Knife pressure too low or dropping completely

Symptom	Reason	Solution
Knife pressure too low or dropping completely	Leaking Hydraulic Hose	Check all hoses and tighten if necessary
Knife pressure too low or dropping completely	Leakage in hydraulic valve	Contact McHale Dealer

15.1.6 Knife pressure too high

Symptom	Reason	Solution
Knife pressure too high	Knives have been raised to max pressure	Lower knives and raise again to set at correct pressure
Knife pressure too high	Faulty hydraulic valve	Contact McHale Dealer

15.1.7 Chamber losing pressure

Symptom	Reason	Solution
Chamber losing pressure	Oil leak	Find leak and resolve
Chamber losing pressure	Relief valve loose / restriction in relief	Contact dealer

15.1.8 Issues with bale rotation/intake

Symptom	Reason	Solution
Baler won't take crop in even though the bale chamber is not full	Drop floor down - this can cause problems with bale rotation	Reset the floor to the working position

15.1.9 Issue with bale quality/density

Symptom	Reason	Solution
Issues with bale quality/density	Density set too low for the crop conditions	Increase the density
Issues with bale quality/density	Crop build up at the tail-gate lower closing point	Clean away loose crop
Issues with bale quality/density	Ground speed too high	Reducing ground speed will allow the machine to pack the bale better
Machine making bales with soft edges/corners	The centre of the bale is being overfilled	See "Swath preparation" on page 88

15.1.10 Machine won't cut the net

Symptom	Reason	Solution
Machine won't cut the net	Bill hook worn and catching on plastic reset bushing	Replace bill hook
Machine won't cut the net	Bill hook has too much free play and is catching on the plastic reset bushing	Realign
Machine won't cut the net	Knife jammed or not enough spring pressure	Check for free movement and increase spring pressure if needed

15.1.11 Chopper knives wont move (activate/disengage)

Symptom	Reason	Solution
Knives won't move (activate/disengage)	Faulty hydraulic valve	Contact dealer
Knives won't move (activate/disengage)	Low Power Supply to the control box	Check power source

15.1.12 Net not cut correctly

Symptom	Reason	Solution
Net not cut correctly	Blunt/rusty knife	Fit new knife
Net not cut correctly	Grease on knife (new machine/machine after winter storage)	Clean grease off knife Use extreme caution and protective clothing!
Net not cut correctly	Knife spring too slack	Adjust knife spring pressure (Located behind the netter drive gears)

15.1.13 Drop floor wont move (up or down) - Pick up moves

Symptom	Reason	Solution
Drop Floor won't move (up and or down)	Faulty hydraulic valve	Contact dealer
Drop Floor won't move (up and or down)	Low Power Supply to the control box	Check power source

16

Certification & Warranty

16.1 Declaration of Conformity

The Declaration of Conformity is provided by **McHale**. It certifies the new machine under all the relevant provisions of the EC Machinery Directive and the National Laws and Regulations adopting this directive.

The declaration gives a description of the machine and its function, along with the model and serial number details. See Declaration of Conformity on the next page.

By any alteration of the machine, the Declaration of Conformity, as well as the CE sign on the machine, loses its validity.

16.2 PDI Form

The PDI (Pre-Delivery Inspection) form is filled out on the commissioning of every new machine, by the **McHale** Dealer. The following checks are completed and signed off:

- All parts and accessories are provided to the customer, with the machine
- Machine is reassembled correctly
- Tyre pressure is correct
- Hydraulics, electrics and lighting are working
- New owner has been instructed on how to operate & maintain the machine

The PDI is included in the Operator Manual, please see page 126.

16.3 Change of ownership pre-checks

The PDI (Pre-Delivery Inspection) form that is filled out on the commissioning of every new machine, should also be used during the transfer of ownership of a **McHale** machine. The same check list must be completed and any areas requiring attention addressed before the re-sale of the machine should occur. Pay particular attention to all safety related areas. Take time to familiarise the new owner with machine operation, maintenance and all its safety features.

16.4 Limited Warranty

Limited Warranty conditions are supplied with each **McHale** product. They cover the terms & conditions associated with abnormal failure under normal working conditions. Please see page 127 for more detail.

Declaration of Conformity



EC MACHINERY DIRECTIVE: 2006/42/EC DECLARATION OF CONFORMITY

We hereby certify that the machinery stipulated below complies with all the relevant provisions of the EC Machinery Directive and the National Laws and Regulations adopting this Directive. Modifications to the machine, without prior approval from the undersigned, will render this declaration null and void.

Machine description and function: Variable chamber round baler & wrapper, producing various sizes of round bales of agricultural fodder and wrapping bales with agricultural bale wrap film.

Model: Fusion Vario **Serial Number:** 90_____

Name of Manufacturer: McHale Engineering
Address: Ballinrobe, Co. Mayo. Rep. of Ireland

Is in conformity with the provisions of the following other EC directives:
2004/108/CE - EMC for the control unit

Technical file compiled by: James Heaney
c/o McHale Engineering
Ballinrobe, Co. Mayo. Rep. of Ireland

Harmonized standards applied:

- EN ISO 12100: Safety of machinery - Basic concepts, general principles for design
 - Part 1: Basic terminology, methodology
 - Part 2: Technical principles and specifications
- EN ISO 4254 Part 1: Agricultural Machinery - Safety and general requirements
- EN 704: Agricultural Machinery - Pick-up balers - Safety

Signed: 
Date: **Place:** Ballinrobe, Co. Mayo, Rep. of Ireland
Name: James Heaney
Position: Design Office Manager

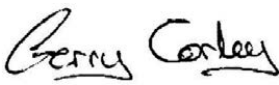
Signed: 
Date: **Place:** Ballinrobe, Co. Mayo, Rep. of Ireland
Name: Gerry Corley
Position: Quality Manager



Pre-delivery inspection form

 PRE-DELIVERY INSPECTION (PDI)			
Dealer:.....		Model: Fusion baler & wrapper	
Full address:.....		Serial No:.....	
.....		Date Delivered:.....	
Fitter:.....		Date Inspected:.....	
Customer:.....			
Full Address:.....		Tel:.....	
.....		Mobile:.....	
.....		E-mail:.....	
ENSURE THAT THE TRACTOR IS OF THE CORRECT SPECIFICATION FOR THIS MACHINE REFER TO THE OPERATOR INSTRUCTOR MANUAL BEFORE MAKING ANY ADJUSTMENTS!			
This machine must be registered on www.mchale.net by the dealer in order to qualify for warranty!			
1. Check that all accessories are with the Owner/Operator. Check Operators Instruction Manual and Parts Lists.		10. Check both Manual and Auto functions on the control box. Run machine through automatic cycle on the control unit.	
2. Ensure machine is re-assembled correctly. (Refer to all assembly instructions supplied)		11. Check for smooth operation of the pick-up reel when machine is run at 540 rpm.	
3. Ensure that the wheels are correctly fitted (i.e. valve to the outside). Torque wheel nuts correctly.		12. Check that all electrics and lights function correctly.	
4. Check for correct tyre type, tread and pressure. (Tyre inflation pressure is ● 1.65 bar (24 psi) ● 2.07 bar (30 psi))		13. Ensure netter operation and netter knife are running smoothly.	
5. Hitch machine to tractor, then connect PTO shaft. Adjust PTO length if required.		14. Check dispenser ring & dispensers are running smoothly & free from damage or grit.	
6. When hitched to tractor check that the machine is level with the ground. Adjust drawbar if necessary. Attach 7-pin plug for lighting system.		15. The operator must be fully aware of all hazards, controls (electric & hydraulic), all functions & safety devices of both the machine and the tractor.	
7. Connect hydraulic hosing to tractor and ensure proper hydraulic setup. Note: Ensure free-flow return to tank.		16. Ensure that the owner/operator reads the operator instruction manual and understands fully all safety & operating aspects of the machine, as described.	
8. Ensure control-unit power supply is 12 V direct from battery otherwise the machine may malfunction.		17. Instruct operator on machine maintenance i.e. check chain tensions, adjustments, tyre pressure and wheel nuts, also areas to be greased daily and oiler/greaser functions.	
9. Ensure that the control unit is on the correct program to suit the machine specification.			
I am satisfied that the above checks have been carried out, and that the machine is complete with all accessories and manuals.			
Signed:.....		(Dealer)	Date:.....
Signed:.....		(Owner)	Date:.....
A signed copy of this form is to be retained by both the dealer and the customer.			

McHale Limited Warranty

McHale Engineering, Ballinrobe, Co. Mayo, Ireland (hereinafter called “the company”) warrants to the original retail purchaser that new products sold and registered with the company, shall be, at the time of delivery, free from defects in material and workmanship, and that such equipment is covered under Limited Warranty providing the machine is used and serviced in accordance with the recommendations in the operator’s manual.

This Limited Warranty covers the equipment for 10,000 bales, or a period of one year starting from the date the equipment is commissioned, whichever comes first.

The online submission of the pre-delivery inspection (PDI) form by the dealer (importer) is taken as evidence of the delivery of the machine to the original retail purchaser. This is compulsory, and is required to record the machine in the **McHale** warranty system.

These conditions are subject to the following exceptions:

- Parts of the machine which are not of **McHale** manufacture, such as tyres, PTO shafts, slip clutches, hydraulic cylinders, etc. are not covered by this Limited Warranty, but are subject to the warranty of the original manufacturer. Warranty claims applying to these types of parts must be submitted in the same way as if they were parts manufactured by **McHale**. However, compensation will be paid in accordance with the warranty agreement of the manufacturer concerned.
- This Limited Warranty does not apply to failure through normal wear and tear, to damage resulting from negligence or from lack of inspection, from misuse, from lack of maintenance and/or if the machine has been involved in an accident, lent out or used for purposes other than those for which it was intended by the company.
- This Limited Warranty will not apply to any product that has been altered or modified in any way without the express permission of the company, or if parts not approved by **McHale** are used in repair.
- The company take no responsibility for any additional costs, including loss of oil and/or consumables incurred during the failure and repair of a product
- The company cannot be held responsible for any claims or injuries to the owner or to the third party, nor to any resulting responsibility.
- Also, on no account can the company be held liable for incidental or consequential damages (including loss of anticipated profits) or for any impairment due to failure, a latent defect or a breakdown of a machine.

The customer will be responsible for the following costs:

- Normal maintenance such as greasing, maintenance of oil levels, minor adjustments, etc. as specified in the operator’s manual.
- Labour charges other than originally agreed, incurred in the removal and replacement of components.
- Dealer’s travel time and travel costs to and from the machine.
- Parts defined as normal wear items such as, but not limited to PTO shafts, chains, tyres, bearings, belts, blades, knives, tines, tine bars, slip clutches, nylon chain runners and slides, etc. that are not covered under the Limited Warranty.

McHale Fusion Vario Baler & Wrapper

The importer will be responsible for the following costs:

- All warranty labour charges.

The warranty is dependent on the strict observance of the following:

- The machine has been put in service by the **McHale** dealer according to our instructions.
- The online pre-delivery inspection (PDI) form has been correctly completed by the dealer.
- A printed version of the PDI form has been signed and dated by the original retail purchaser. This copy is to be stored by the dealer and made available to **McHale** when requested.
- The warranty claim is submitted using the **McHale** online claims system.
- The warranty claim must be submitted by the original retailing **McHale** dealer only.
- The decision of the company in all cases is final.
- Damaged parts should be held by the dealer until credit has been given, or a returns request has been issued.
- Parts must be returned to **McHale**, with the **McHale** claim number written clearly on each individual part. These parts must be free from dirt and oil. If a part is returned in an unfit state, the claim will be refused.
- If damaged parts have been returned to the company and warranty is refused, the dealer is allowed a period of one month from the date of receiving our notification to request the return of the damaged parts to the dealer site.

Further conditions - limits of application and responsibility:

- This Limited Warranty cannot be assigned or transferred to anyone without the prior written consent of the company.
- **McHale** dealers have no right or authority to assume any obligation or take any decision on the company's behalf, whether expressly or tacitly.
- Technical assistance given by the company or its agents for repairing or operating equipment does not lead to any responsibility on the company's behalf and cannot under any circumstances bring novation or derogation to the conditions of the present Limited Warranty.
- The company reserves the right to incorporate changes in its machines without prior notice and without obligation to apply these changes to machines previously manufactured.
- The present Limited Warranty excludes any other responsibility, whether legal or conventional, express or implied, and there are no warranties extending beyond those defined herein.