

Iso-Riant[®] básadýnur og dúkur



Leiðbeiningar um uppsetningu



Fjós eru okkar fag

Ath. gula hliðin á dúknum snýr upp og svart niður

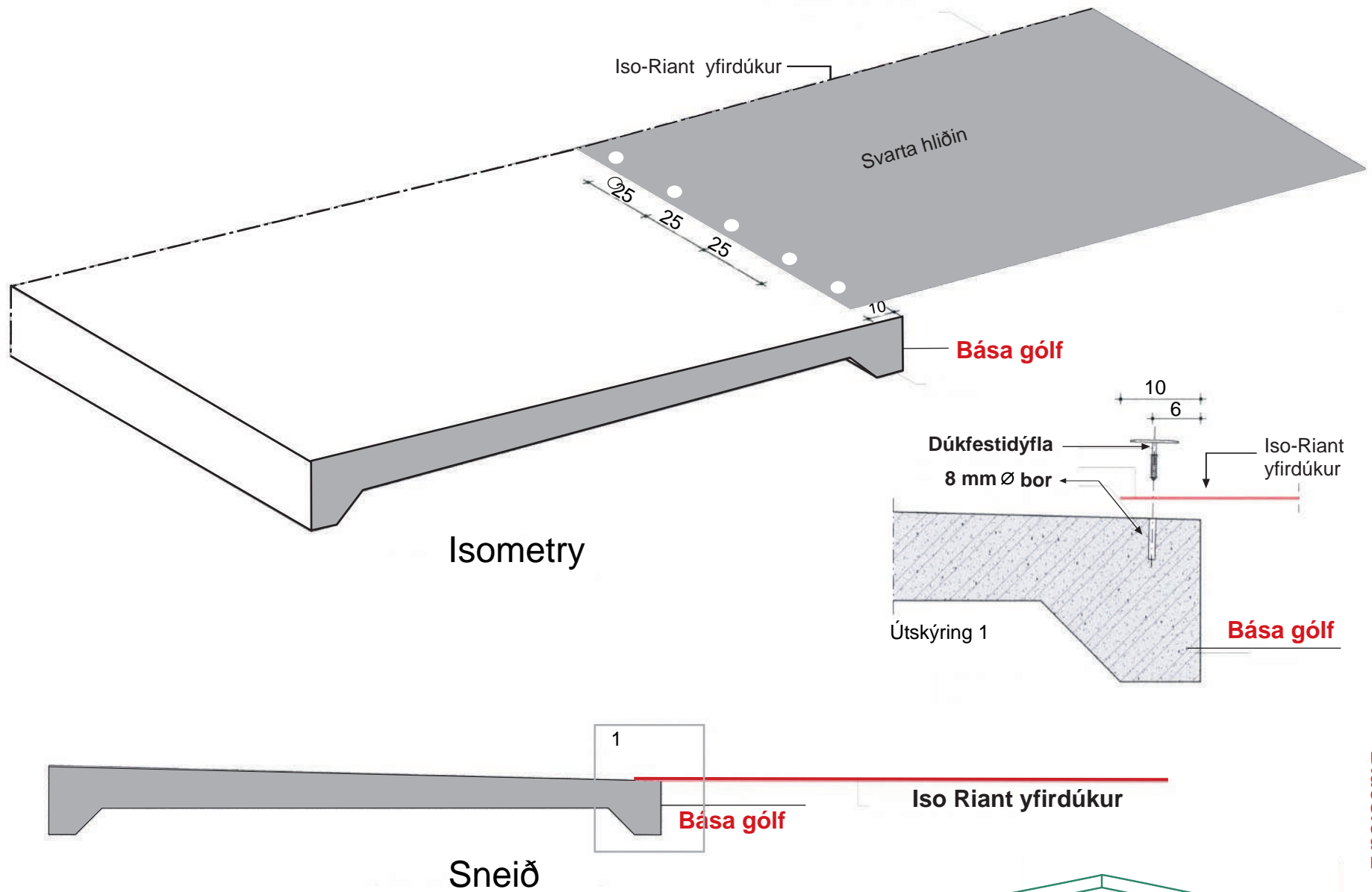

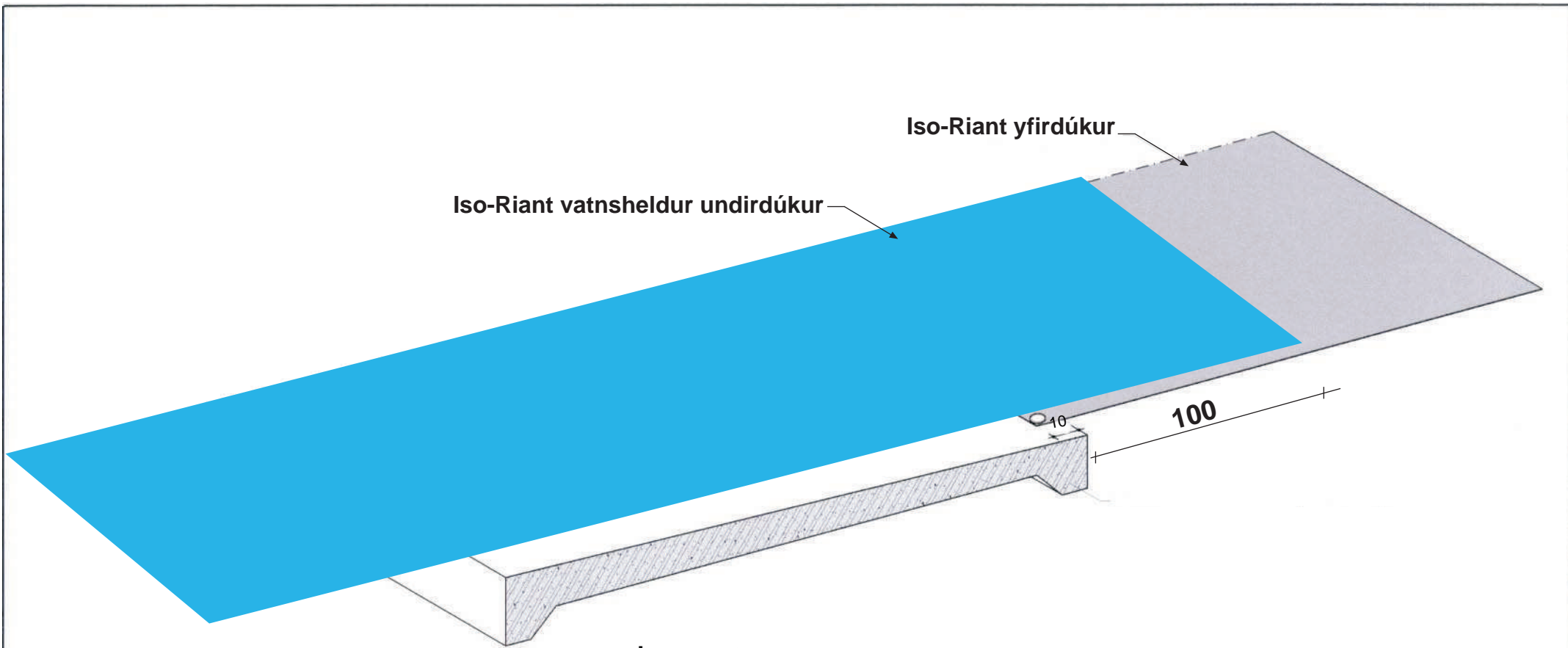

Isometry

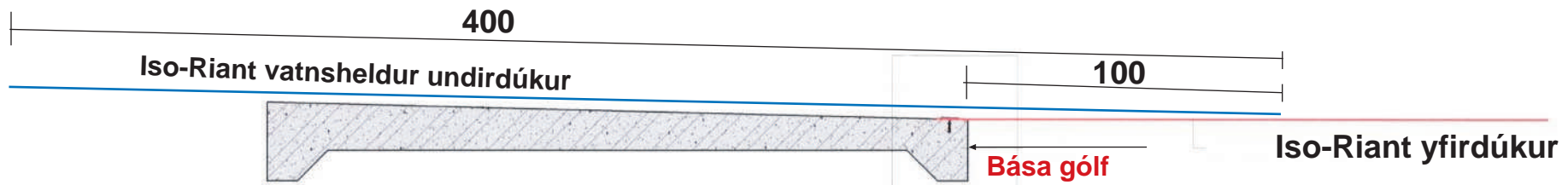

Sneið



Ath. munið að stytta dýnuna í 158 - 160 sm. (fyrir kýr)

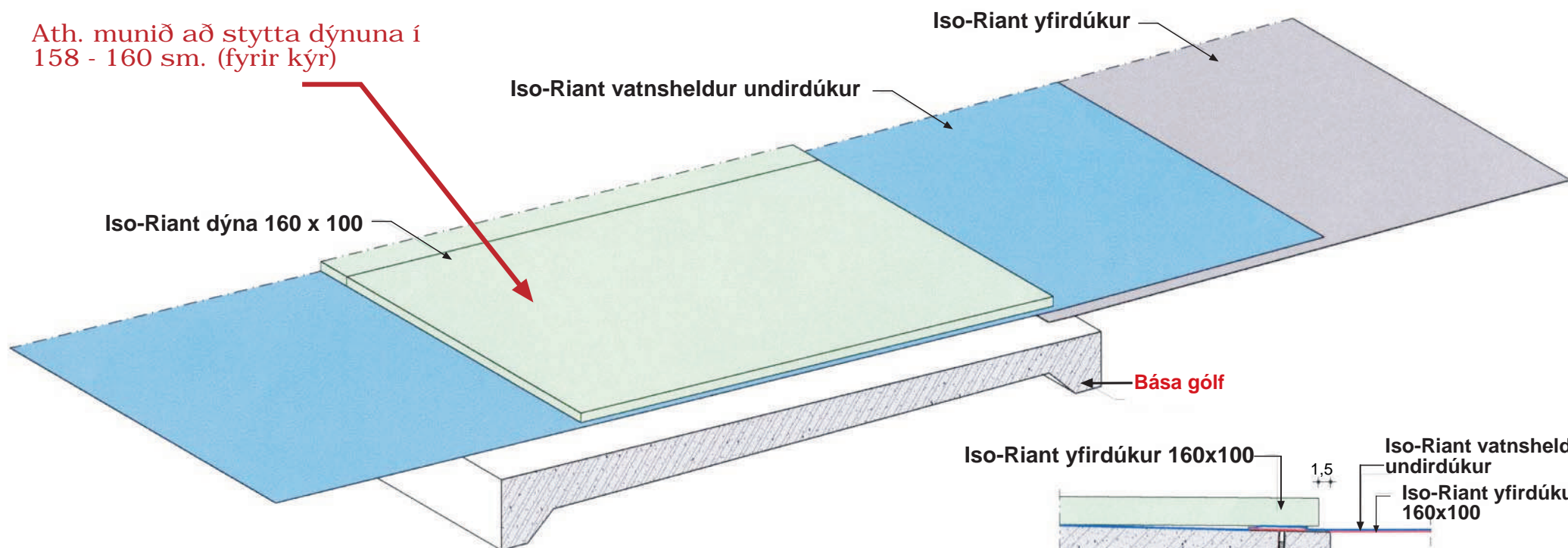

Isometry

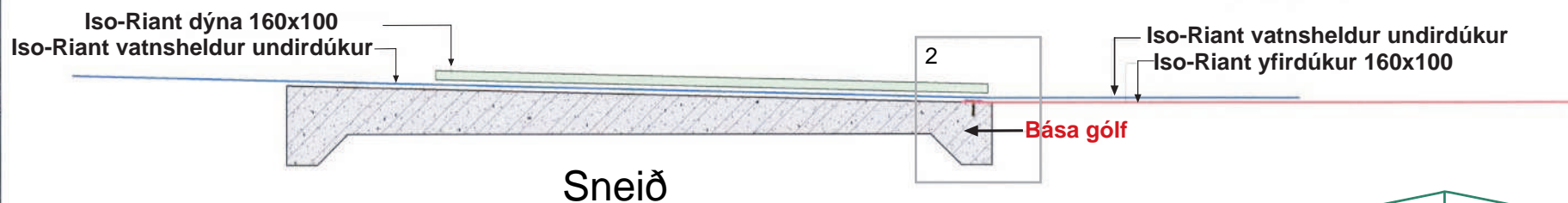
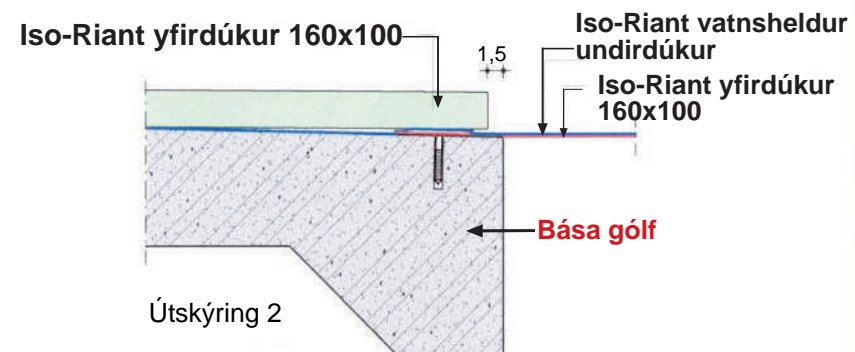

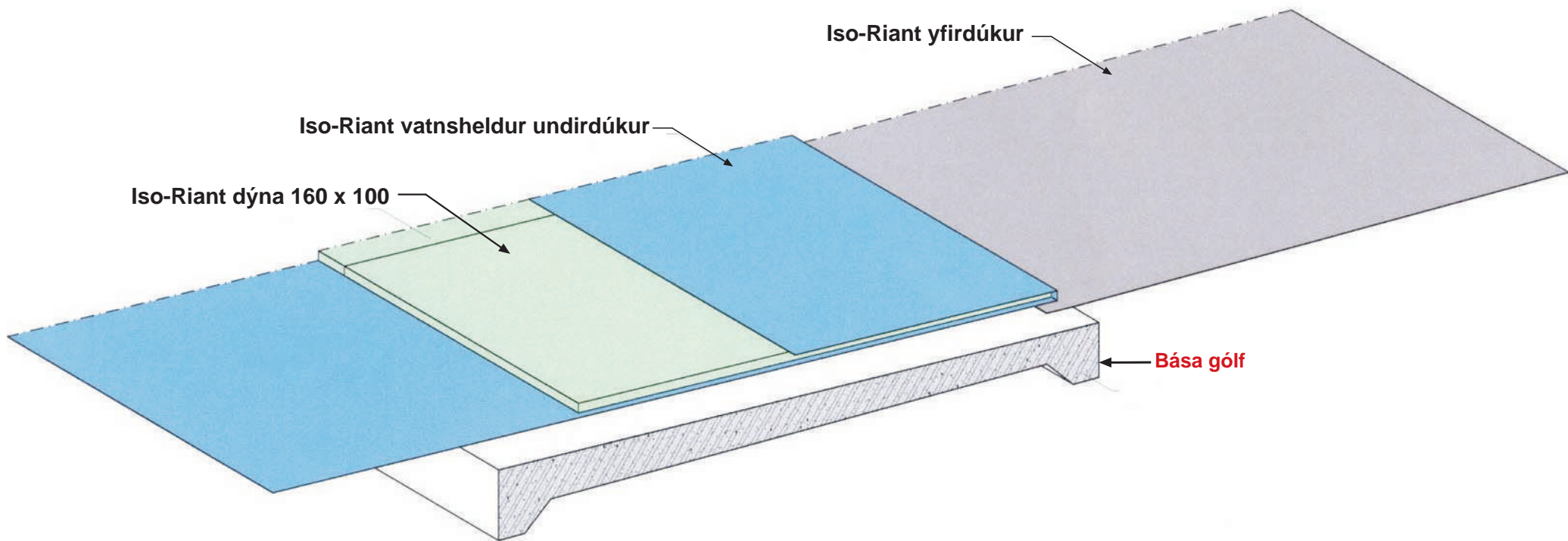

Iso-Riant vatnsheldur undirdúkur

Iso-Riant dýna 160 x 100

Iso-Riant yfirdúkur

Bása gólf

Isometry

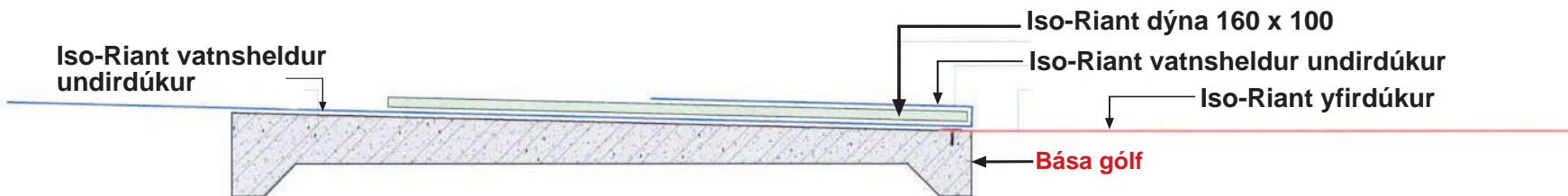

Iso-Riant vatnsheldur undirdúkur

Iso-Riant dýna 160 x 100

Iso-Riant vatnsheldur undirdúkur

Iso-Riant yfirdúkur

Bása gólf

Sneið

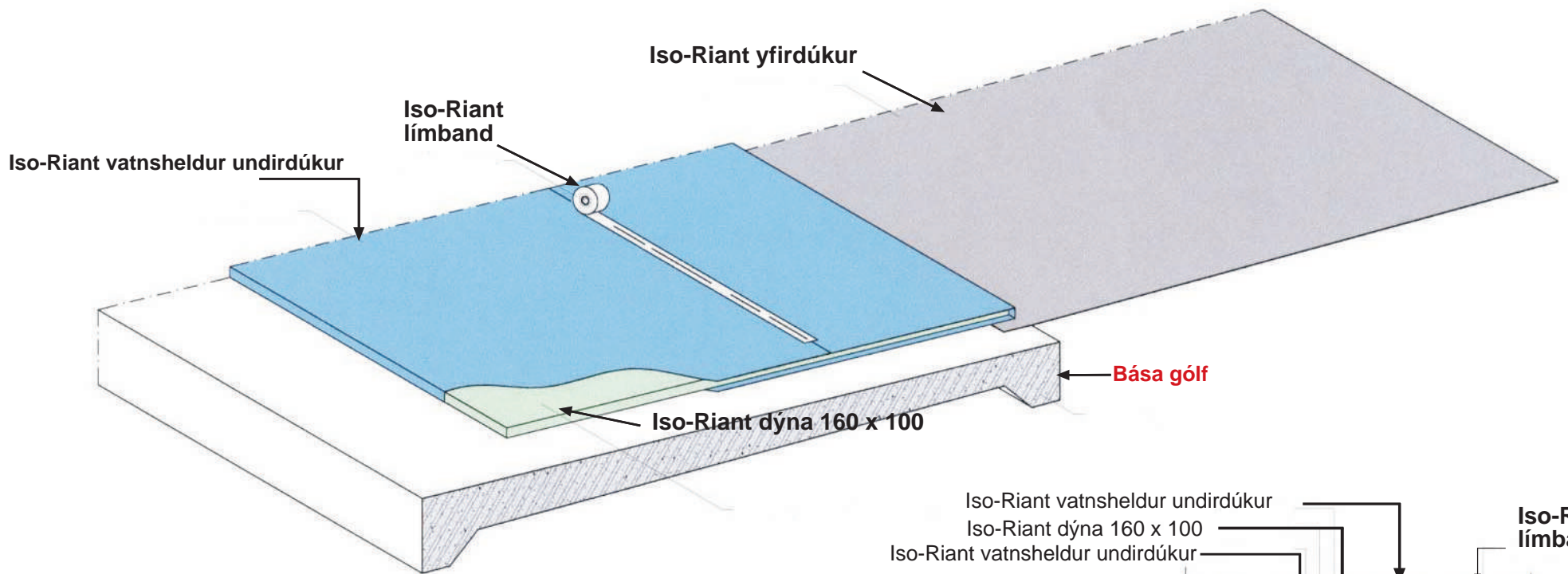

Isometry

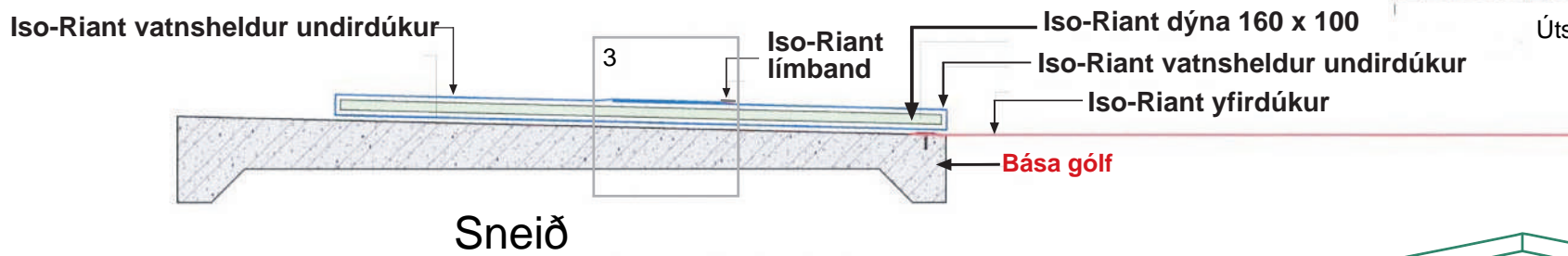
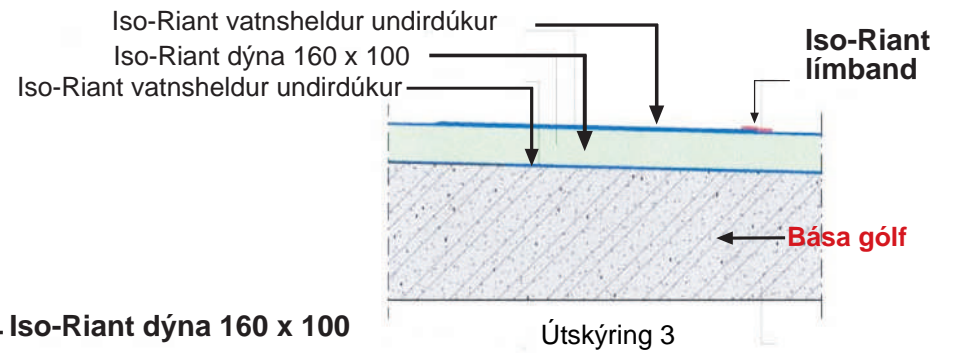

Sneið

Blaðsíða 6



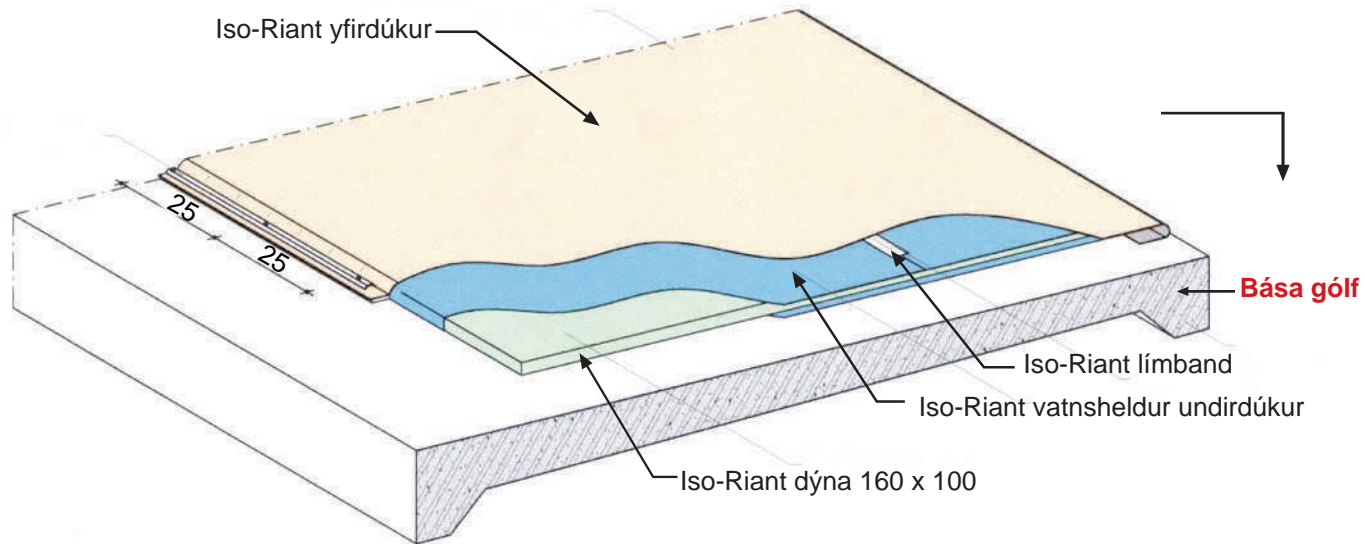

Isometry

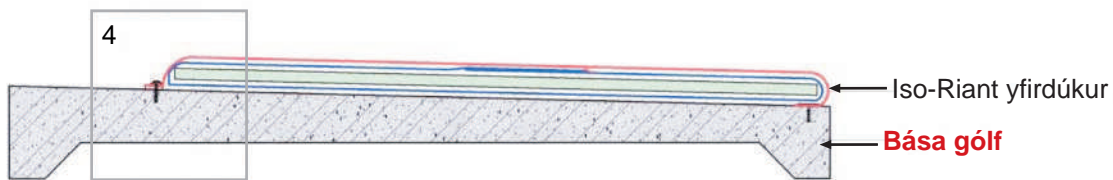

Sneið

