

# STORTH

EXPERTS IN SLURRY MANAGEMENT



Storth have worked hard with the end user to develop a suitable range of Slurry Pumps which will aid Slurry Management on every farm allowing us to provide the right Pump solution every time.

## High Performance Slurry Pumps

Specialist Manufacturers of  
Slurry Handling Equipment



STORTH  
Stoneleigh Park, Station Road,  
Holme, Nr Carnforth, Lancashire, LA6 1HR.

Tel: 0044 1524 781 900

Email: [info@storthmachinery.co.uk](mailto:info@storthmachinery.co.uk)

Manufactured in the UK

[www.storthmachinery.co.uk](http://www.storthmachinery.co.uk)

# Superjet Static 5" & 6" (no agitator)

The Storth Superjet Static (no agitator) Pump is a PTO driven static pump, ideal for use in a reception tank to pump slurry to the slurrystore. The heavy duty, fully galvanised frame ensures long-lasting performance from this machine. Slurry is delivered directly from the impeller drum to the male bauer discharge fitting (as per cover page).

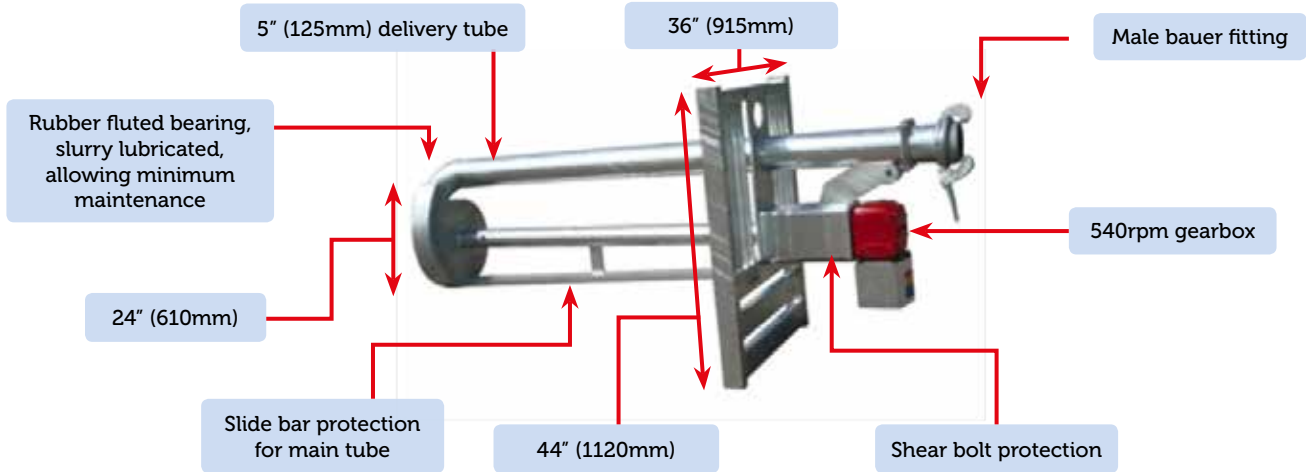

# Superjet Static 5" & 6" (with agitator)

The Superjet Static (with agitator) Pump is ideal for use when slurry needs agitating in the reception tank before pumping it into the slurrystore. This pump is fitted with an under surface agitator to the main delivery tube to divert the slurry, causing a high pressure jet agitation. Moving a handle at the pump head diverts slurry up to the male bauer discharge fitting (standard) (as per cover page).

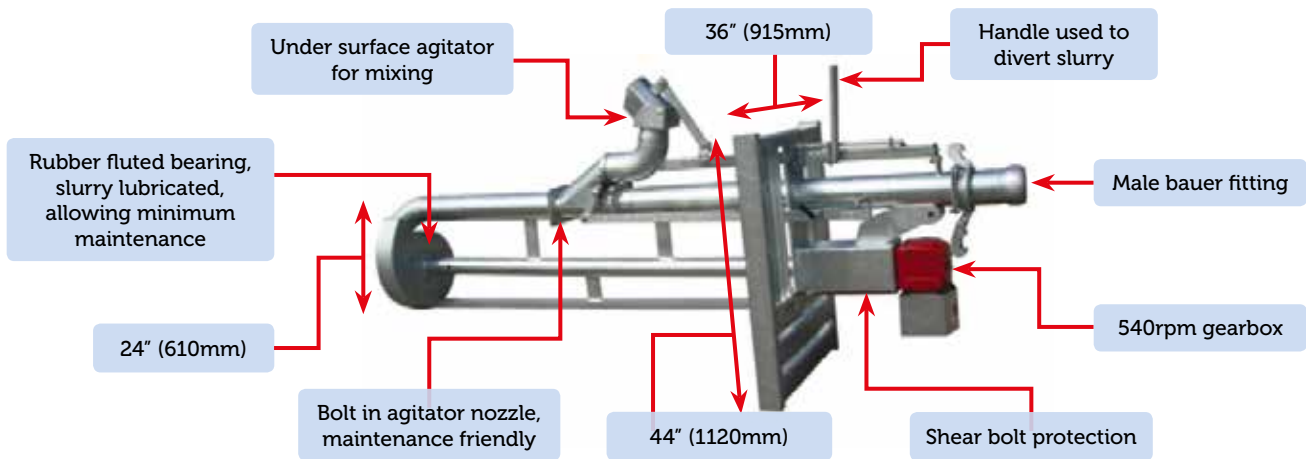

## Technical Details

- 540rpm gearbox
- Fully galvanised
- 6 blade impeller, 360mm x 100mm

## 5" (125mm)

- 60-70hp required
- 5" (125mm) discharge pipe
- 2500 gallons (11,365L) mixing capacity per minute

## 6" (150mm)

- 100-120hp required
- 6" (150mm) discharge pipe
- 4500 gallons (20,475L) mixing capacity per minute

Lengths available from 5ft (1.5m) up to 16ft (5m). Lengths are measured in 1ft (300mm) increments.



# Superjet 2-Point Linkage

The Superjet 2-Point Linkage Pump is a high specification design as the Superjet 3-Point with quick attachment to the link arms. This machine has a high capacity output with options of 5" and 6" pipework. This machine will need to be placed into position before attaching the PTO shaft. The PTO shaft must be disconnected before moving the machine to different tanks. Full hydraulic movement is also available on all functions from the tractor seat.

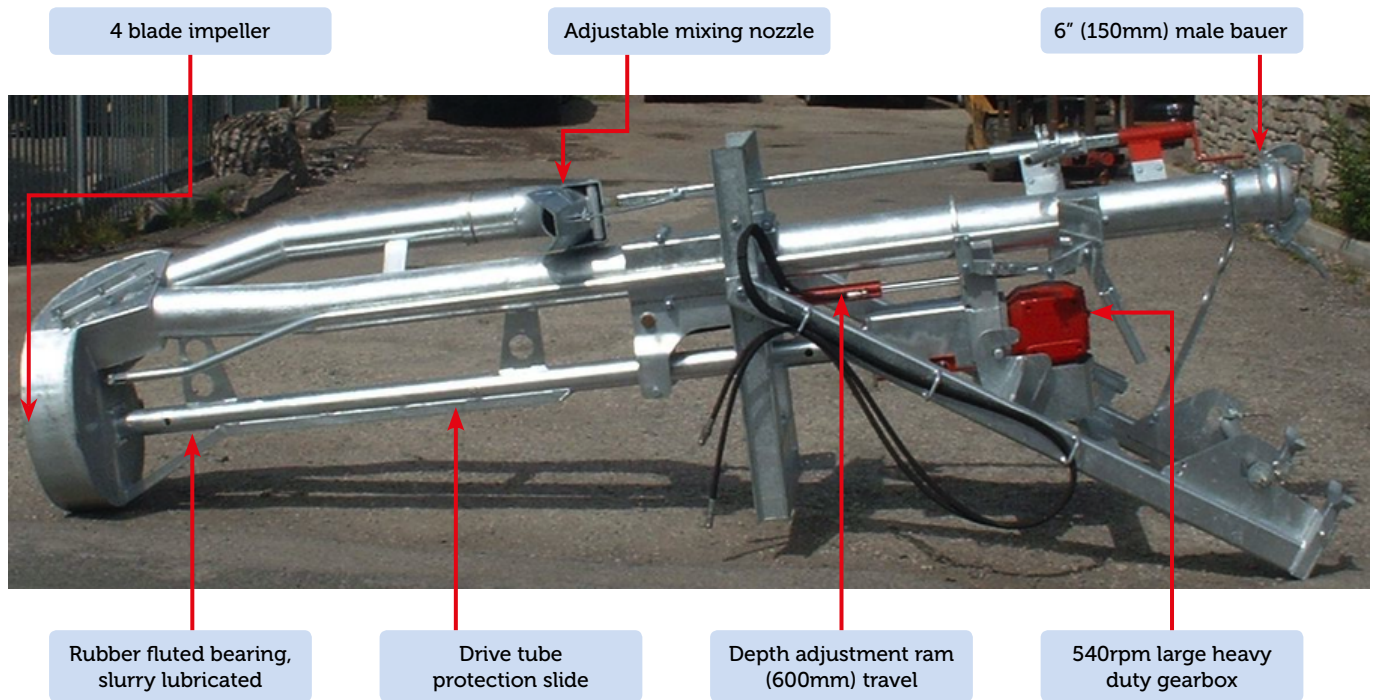

## Technical Details

- Fully galvanised
- Hydraulic ram allowing 600mm travel on the depth
- 4 blade impeller, 430mm x 150mm
- 540rpm Large heavy duty gearbox
- Full hydraulic on all functions available

### 5" (125mm)

- 80-100hp required
- 5" (125mm) discharge pipe
- 3000 gallons (13,638L) mixing capacity per minute

### 6" (150mm)

- 100-120hp required
- 6" (150mm) discharge pipe
- 4500 gallons (20,457L) mixing capacity per minute

**Models Available:** 6-8ft (1.8-2.4m) length • 8-10ft (2.4-3.0m) length • 10-12ft (3.0-3.6m) length

# Pump Accessories

As all applications of slurry management are not all the same, Storth have developed a range of accessories to fit all our Slurry pumps.

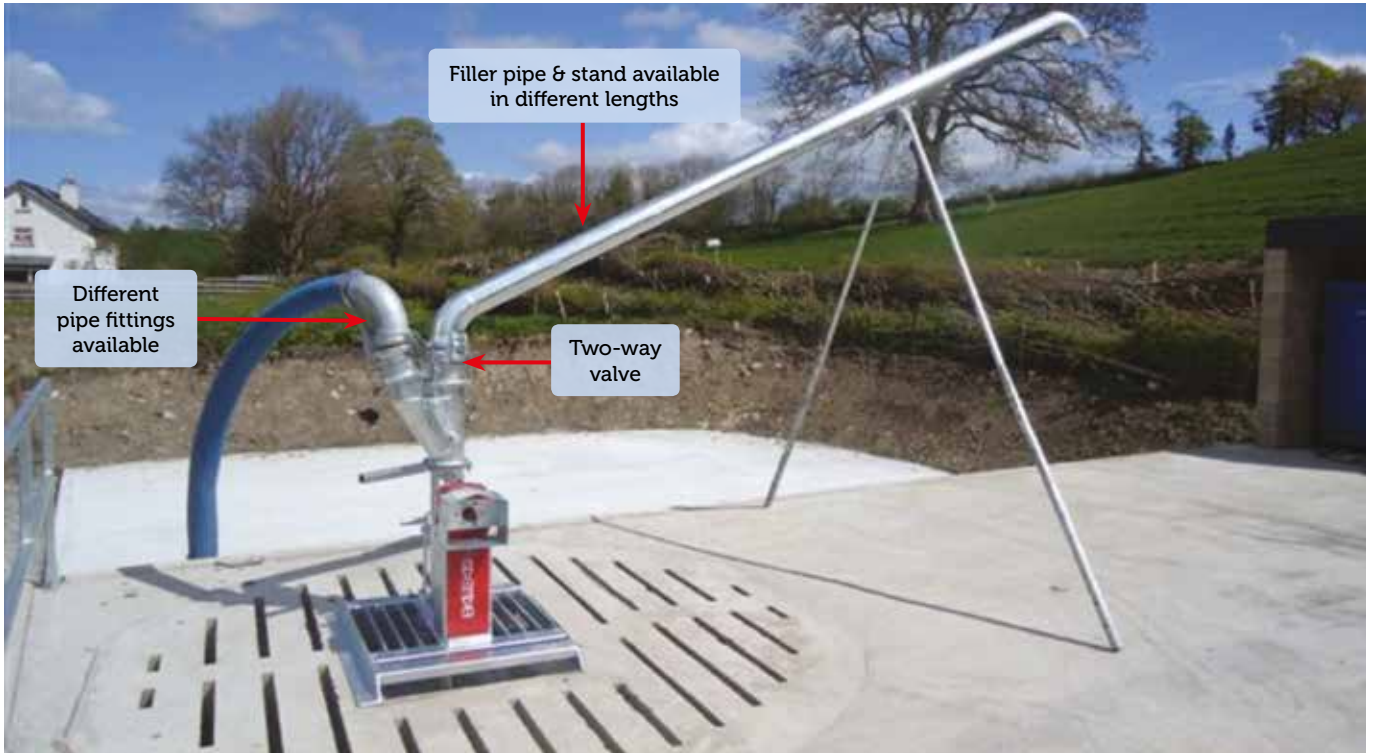

## Re-Circulation Pump

The 6" Re-Circulation pump is used to enable the mixing of above ground storage tanks without the need for a reception tank. The slurry enters the re-circulation pump from a head pressure of slurry entering the impeller housing with a 1,000rpm input. The machine will discharge at 3,000gpm.





# Superjet 3-Point Linkage 5" & 6"

The Superjet 3-Point Linkage is a high capacity pump with options of 5", 6" and 8" pipe work. Fitted with a high capacity drum, the Superjet 3-Point Pump enables high volumes of slurry to be moved long distances. The under surface agitator will give incredible agitation prior to pumping. When moving this pump from tank to tank the PTO can be left attached to the tractor and machine. This extra option is full hydraulic movement on all functions to allow full control from the tractor seat.

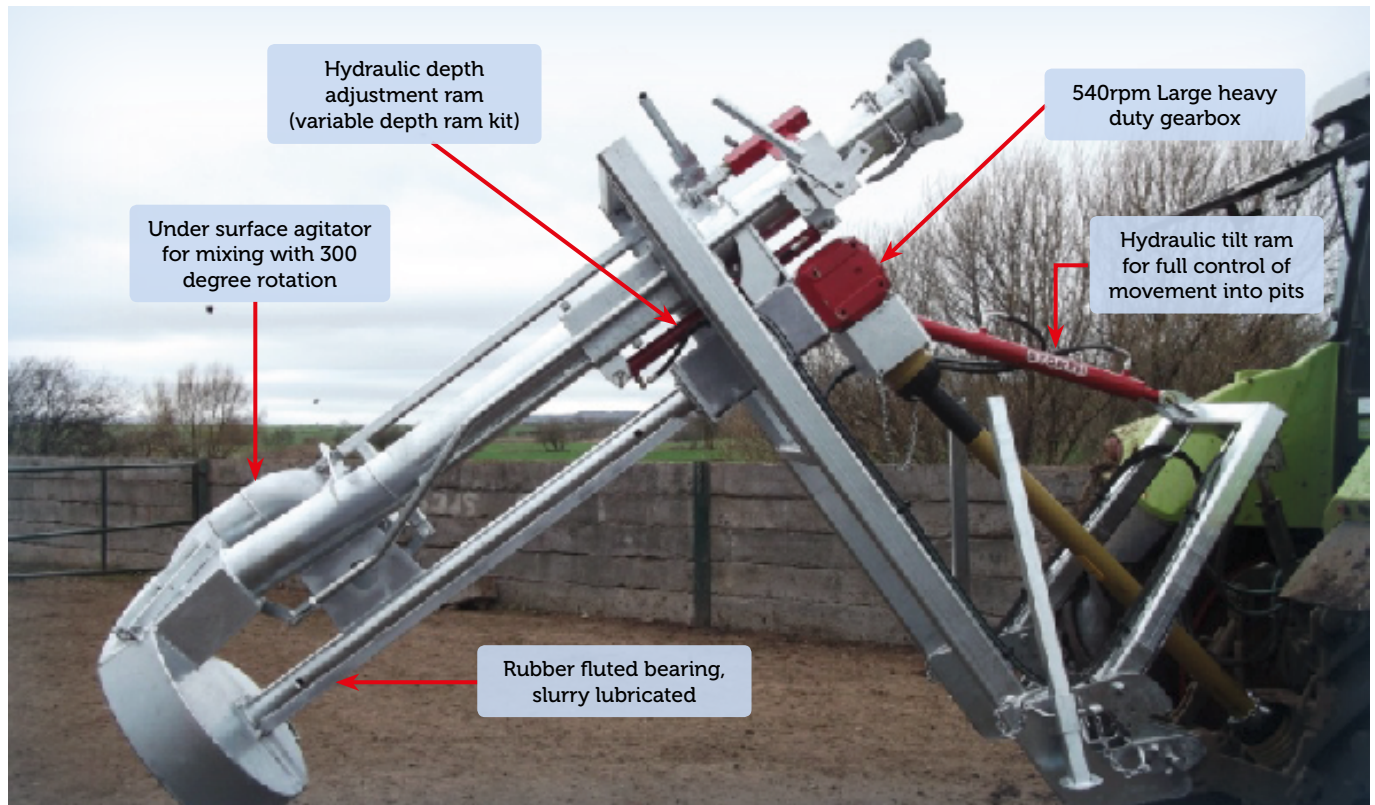

## Technical Details

- Variable depth ram kit available to mix different tank depths
- 4 blade impeller
- 540rpm large heavy duty gearbox
- Full hydraulic on all functions available
- PTO included

## Models Available

Lengths available from 6ft (1.8m) up to 12ft (3.6m). Lengths are measured in foot (300mm) increments.

## Or models with variable depth Ram Kit

- 6-8ft (1.8-2.4m) length
- 8-10ft (2.4-3.0m) length
- 10-12ft (3.0-3.6m) length



# Superjet 3-Point Linkage 8"

The Superjet 3-Point Linkage 8" Pump is the ultimate mixer pump with unrivalled performance and high quality construction which allows this machine to satisfy the larger farmer and contractor's slurry problems. All models are all fully hydraulic controlled from the tractor seat, hydraulic tilt ram, hydraulic depth adjustment, hydraulic motor for rotating the mixer nozzle and a hydraulic ram for moving the mixer nozzle flap up and down. All of these functions can be run from a minimum of two double acting services from the tractor.

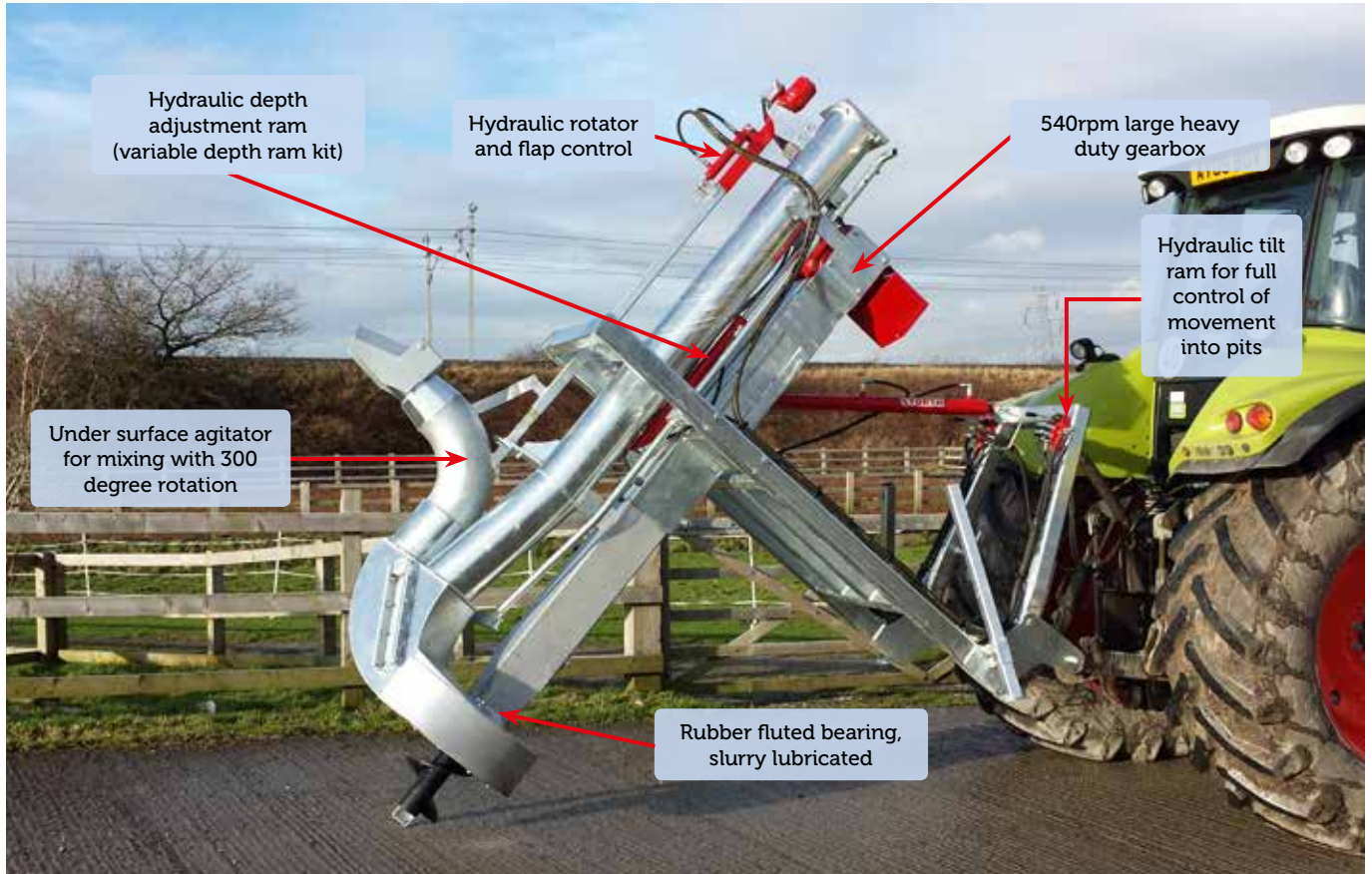

## 5" (125mm)

- 80-100hp required
- 5" (125mm) discharge pipe
- 3000 gallons (13,638L) mixing capacity per minute

## 6" (150mm)

- 100-120hp required
- 6" (150mm) discharge pipe
- 4500 gallons (20,457L) mixing capacity per minute

## 8" (175mm)

- 160-180hp required
- 8" (175mm) discharge pipe
- 6500 gallons (29,549L) mixing capacity per minute



# Electric Pumps

Storth have developed a range of electric driven pumps to enable the farmer to manage slurry automatically without the use of a tractor. Storth Electric Pumps all require 3 phase electric and are available in different motor sizes, dependent on the application. Our Electric Pumps can be set up on float switches to allow the pump to start and stop automatically when the slurry reaches a certain level.

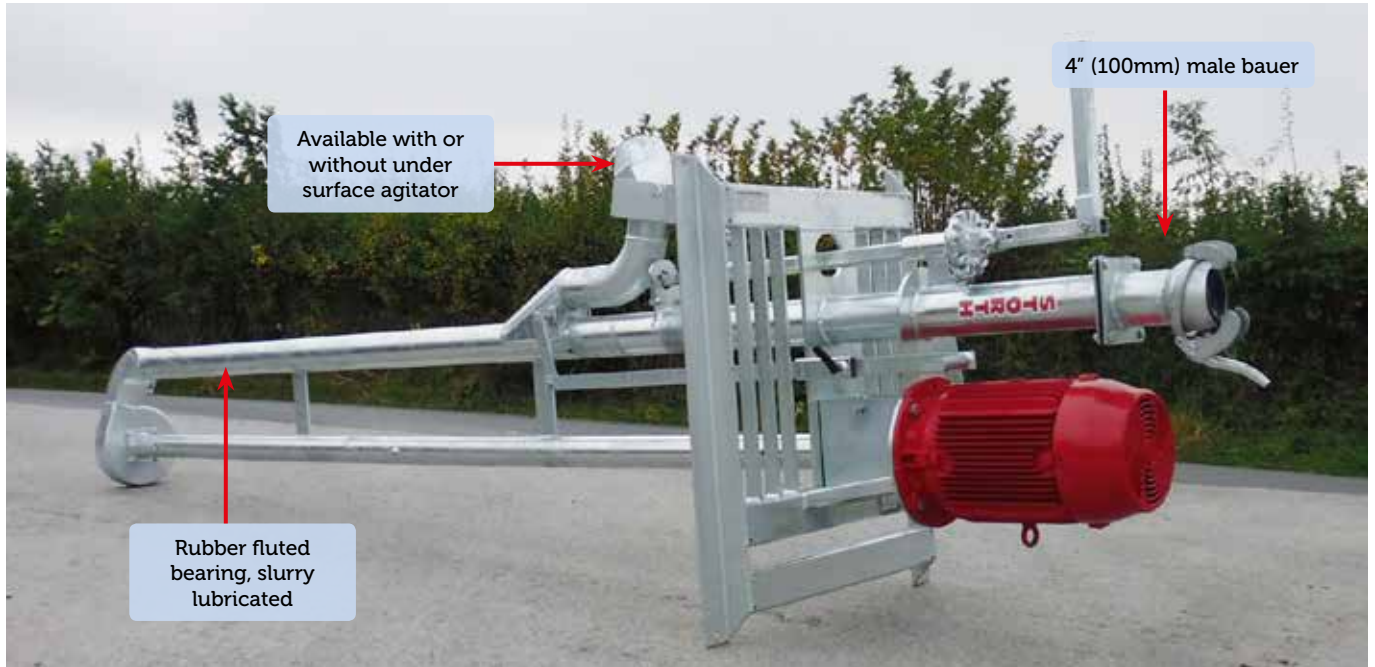

## Technical Details

- 3 phase electric is required
- 4" & 5" (100mm & 125mm) discharge pipe
- Fully galvanised
- Available with or without the under surface agitator
- Supplied with Storth control panel

## Models Available

- Lengths available from 6ft (1.8m) up to 16ft (5m).
- Different sizes of motor available on all lengths: 11kw, 15kw, 18.5kw & 22kw.

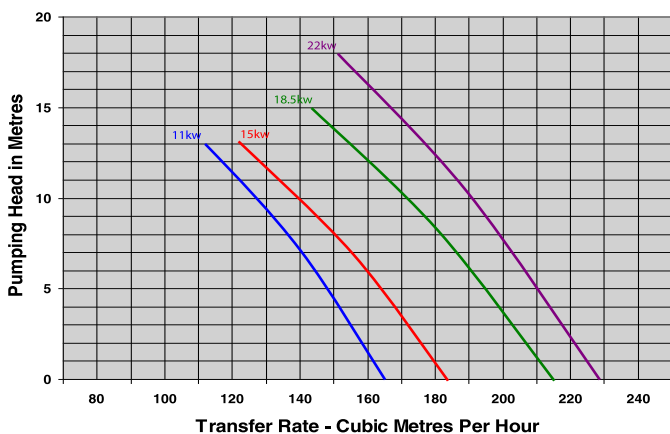



# Centrifugal Chopper Pumps

Storth offer our homegrown NovaST Centrifugal Chopper Pump as well as the SX range from Bauer and K80 range from Cri-Man. It is our intention to supply the most suitable pump for your application; careful consideration is required depending on material viscosity, horsepower availability, pressure and flow.

The Chopper Pump is operated by a drive unit (e.g. electric motor, hydraulic motor or PTO), which turns the impeller and the cutting system. An open impeller design is used to successfully pass the macerated solids or thick slurry.

Storth's experience and expertise with Centrifugal Chopper Pumps in slurry management and slurry distribution systems enables us to specify the pump most appropriate to your application.



## Technical Details

- 3-point linkage galvanised frame
- PTO with sheer bolt
- Hydraulic suction primer
- Galvanised pipe work subject to choice
- Pump performance subject to pump choice

# Hydraulic Pumps

The Hydraulic Pump range starts at 4" (100mm) up to 6" (150mm). These can be used in many applications from pumping water to pumping slurry. The wheel kit version is used to roll down lagoon banks to enable faster filling of slurry tankers or helping umbilical pumps to keep fully primed giving a constant pumping supply to the field. Hydraulic Pumps are also a flexible option for transferring liquids and slurry from pit to pit if the accesses of tractors is impossible as we can run hydraulic hoses to the point of where the tractor can be located.

## Technical Details

- Oil flow 40L to 65L (4" pump)
- Oil flow 80L to 200L (6" pump)
- Wheeled version 6m long galvanised pipe
- 3/4" hydraulic hoses 7m (6" pump)
- 1/2" hydraulic hoses 5m (4" pump)
- Over pressure pipe return
- Pumping capacity up to 800gallons (3,636L) per minute (depending on consistency and oil flow)







**APPLY IT**



**SCRAPE IT**



**HOSE & REEL IT**

# **STORTH**

**EXPERTS IN SLURRY MANAGEMENT**



**PUMP IT**



**PUMP IT**



**MIX IT**



**SEPARATE IT**



**STORE IT**

**Notes:**

.....  
.....  
.....  
.....  
.....  
.....  
.....  
.....

# STORTH

EXPERTS IN SLURRY MANAGEMENT



SCRAPE IT - PUMP IT - STO



**WITH A COMPLETE RANGE OF SLURRY MANAGEMENT EQUIPMENT, WE CAN HELP YOU CREATE THE IDEAL SOLUTIONS OR UPDATE YOUR CURRENT SYSTEMS**



RE IT - MIX IT - SPREAD IT

# STORTH

EXPERTS IN SLURRY MANAGEMENT

For additional information and advice  
please contact your Storth representative

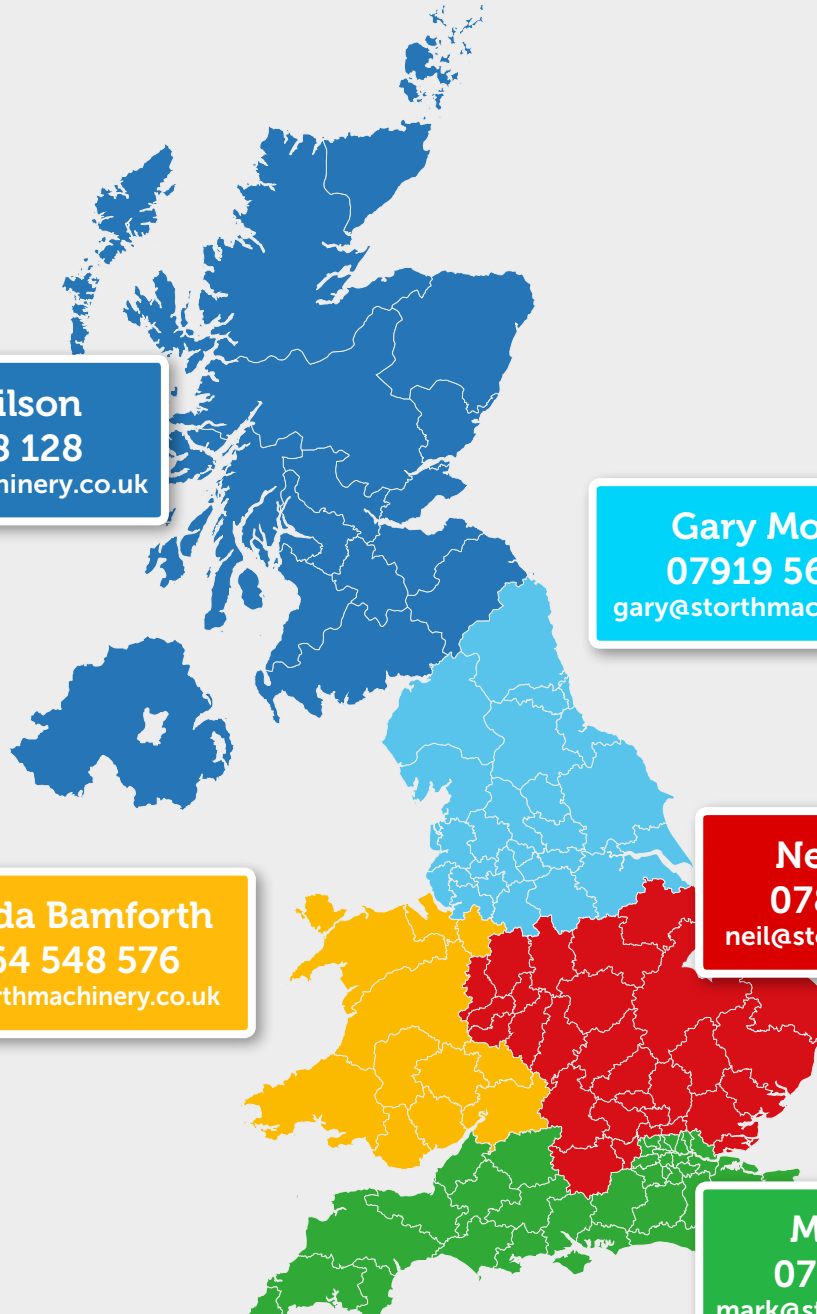

**Robert Wilson**  
07769 728 128  
robert@storthmachinery.co.uk

**Gary Morland**  
07919 563 796  
gary@storthmachinery.co.uk

**Amanda Bamforth**  
07464 548 576  
sales@storthmachinery.co.uk

**Neil Robinson**  
07887 855 048  
neil@storthmachinery.co.uk

**Mark Longly**  
07818 053 159  
mark@storthmachinery.co.uk

**STORTH**  
EXPERTS IN SLURRY MANAGEMENT

Stoneleigh Park, Station Road,  
Holme, Nr Carnforth, Lancashire, LA6 1HR

Manufactured in the UK

Tel: 0044 1524 781 900

Fax: 0044 1524 781 006

Email: info@storthmachinery.co.uk

GLOBAL SALES  
**Simon Jones**  
07527 539 718  
simon@storthmachinery.co.uk



[www.storthmachinery.co.uk](http://www.storthmachinery.co.uk)